



**aquatherm green** pipe ti

**aquatherm blue** pipe ti

**Pre-insulated pipe systems made of polypropylene**  
for district heating



**aquatherm**

state of the pipe



Our sales and delivery conditions (January 2014) and the contacts of our technical sales and distribution see on our homepage [www.aquatherm.de](http://www.aquatherm.de).

Subject to technical alterations, errors and misprints excepted. With the edition of this catalogue, all former ones become void.

**CONTENTS**

– Service	4-5	– Preparation of the seal areas	42
<b>Features</b>	<b>6</b>	– Assembly of melting adhesive strips	43
– Pipe system aquatherm ti	6	– Assembly of casing shrink film	44
Fields of application		– Positioning of the shrink sleeve	45
– Medium pipes	7-11	– Shrinking sequence /	45
Material		Quality control - „finger test“ /	
Environment		Processing of the tension tape	
Use of metal deactivators		– Quality control by „finger tip test“	46
System advantages		Final control	
aquatherm green pipe ti-faser composite pipe SDR 9		Recommendations	
aquatherm blue pipe ti-faser composite pipe SDR 11/17.6		Elements / System review	
aquatherm blue pipe ot ti faser composite pipe SDR 11		<b>aquatherm ti - article list</b>	<b>47</b>
Dimensions		<b>Applications</b>	<b>59-60</b>
Permissible working pressure	12	<b>Notes</b>	<b>61-62</b>
– Insulation			
Material			
Material parameters			
– Casing pipes	14		
Material			
Material parameters			
– aquatherm ti data sheet	15		
Dimensions			
<b>Processing</b>	<b>16</b>		
– Tools and accessories	16-19		
Assembly of welding tools			
Heating-up phase / Handling			
Standards and data			
– Notes for preparation	20-23		
– Heating-element socket welding	24		
with the manual welding device			
– Heating-element socket welding with	25-26		
manual welding device and electric welding jig			
– Heating-element socket welding with	27-28		
the welding machine			
– Heating-element butt-welding with	29-30		
the butt-welding machine type: Light			
<b>Assembly</b>	<b>31</b>		
– Mono top 40 for post enveloping	31-36		
– Corrosion protective tapes	37		
– Product specification	38		
Storage and safety guidelines / Equipment list			
for processing			
– Shrink sleeve system	39		
– Backfilling trench / Flame intensity	40		
– Casing preparation /	40		
Insulation half-shell installation			
– Marking of shrink sleeve position	41		

# SERVICE

## TECHNICAL HOTLINE

+49 (0)2722 950 200

info@aquatherm.de www.aquatherm.de

### Parent plant Attendorf

**aquatherm GmbH**  
Biggen 5  
D-57439 Attendorf  
Phone: +49 (0) 2722 950-0  
Fax: +49 (0) 2722 950-100

### Subsidiary Radeberg

**aquatherm GmbH**  
Wilhelm-Rönsch-Str. 4  
D-01454 Radeberg  
Phone: +49 (0) 3528 4362-0  
Fax: +49 (0) 3528 4362-30



#### Field staff

In addition to the regular training service at Attendorf and Radeberg aquatherm field staff are available to assist customers, on site, throughout Germany.



#### Training service

In addition to training service through the merchant network aquatherm offers its customers training, free of charge, at its training centres at Attendorf and Radeberg.

#### Fair

aquatherm is represented on all important fairs relevant for the sanitary and heating sector in Germany or abroad with its own exhibition booth. For more information regarding fairs near to you, please visit internet page: [www.aquatherm.de](http://www.aquatherm.de).

## CERTIFICATIONS IN ACCORDANCE WITH ISO 9001, 14001 & 50001

Since 1996 aquatherm has been meeting the requirements of the certifiable quality management system according to DIN ISO 9001. The 2012 TÜV certificate was extended by the environmental management system according to ISO 14001 and currently by the energy management system according to ISO 50001.

This success is a great contribution and represents a further step to strengthen our competitive position and to meet the high requirements and the responsibility for our customers, partners and the environment.



Management System  
ISO 9001:2008  
ISO 14001:2004  
ISO 50001:2011  
www.tuv.com  
ID 0091005348



### Laboratory

The aquatherm laboratory: from the testing of granulate through to the finished product the customer can be assured of only the highest quality products.



### Software-Service

The aquatherm-software service provides Datanorm-files, an independent graphical program (liNear), and the appropriate training.



### Miscellaneous

Different aquatherm-CD's, prospects, catalogues, poster, leaflets, mailings,calen-dars, a.s.m. are investigated and produced from the internal advertising department. All information regarding the company, the technology, the products, the various trainings and fairs as well as all catalogues in pdf-form can be called and downloaded from the aquatherm - website: [www.aquat-herm.de](http://www.aquat-herm.de).

# SERVICE

# aquatherm green pipe ti

# aquatherm blue pipe ti

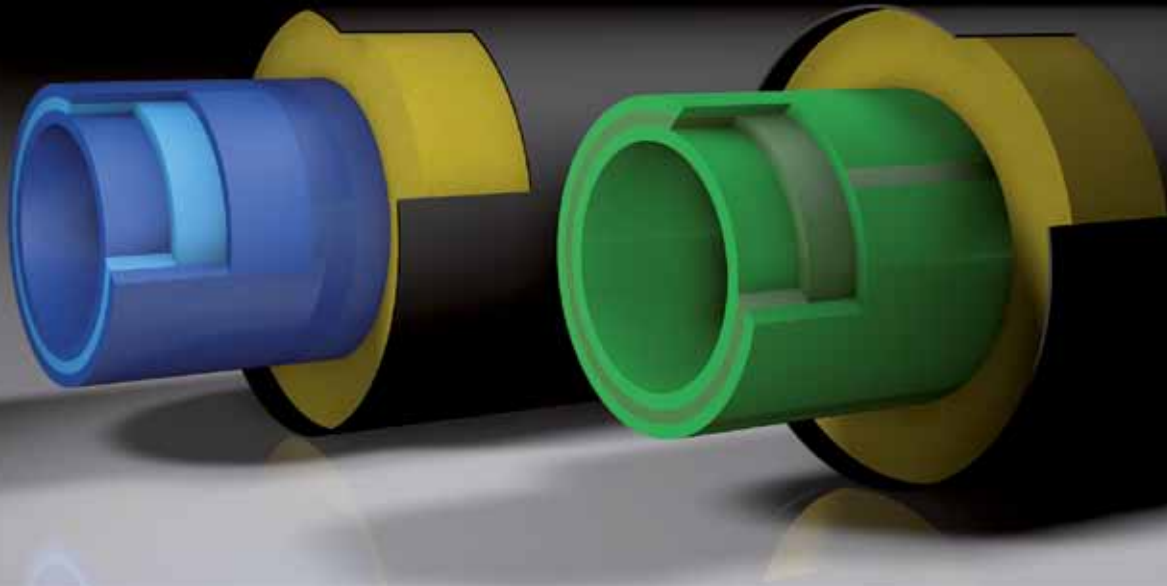

## aquatherm ti - PRE-INSULATED PIPE SYSTEMS for district heating

One of the most energy-efficient methods of transporting hot potable water as well as heating or cooling water covering long distances is the application of underground piping. To achieve the necessary insulating characteristics for this type of application, aquatherm offers the factory-made pre-insulated ti pipe system with different medium pipes.

The aquatherm ti pipe systems are insulated with PUR rigid foam and coated with a casing pipe made of PEHD.

All medium pipes are plastic-fibre composite pipes.

### Medium pipes

- ➡ **aquatherm green pipe ti**  
faser composite pipe system SDR 9  
pipe system for potable water  
in dimensions 32-250 mm
- ➡ **aquatherm blue pipe ti -**  
faser composite pipe system  
SDR 11 in dimensions 32-315 mm  
SDR 17.6 in dimensions 160-315 mm  
pipe system for heating, cooling and waste water
- ➡ **aquatherm blue pipe ot ti -**  
faser composite pipe system SDR 11  
oxygen-tight pipe system for heating- and industrial  
water in dimensions 32-250 mm

### Fields of application

System recommended due to its technical advantages: ●

Application of the system is suitable: ○

aquatherm green pipe ti    aquatherm blue pipe ti    aquatherm blue pipe ot ti

	aquatherm green pipe ti	aquatherm blue pipe ti	aquatherm blue pipe ot ti
<b>Potable water application</b>	●		
<b>Climate technology</b>	○	●	●
<b>Chilled water technology</b>	○	●	●
<b>Swimming pool technology</b>	●	●	
<b>Rainwater application</b>	●	●	
<b>Irrigation</b>	●	●	
<b>Disctriect heating</b>		●	●
<b>District cooling</b>		●	●
<b>Application in the field of ship building</b>	●	●	●
<b>Industrial liquids</b> considering the material resistance	●	●	●

## MEDIUM PIPES

### Material

The medium pipes, integrated in the aquatherm ti pipe system, are made of fusiolen® PP-R.

Special heat and extraction stability are only two of the features of this material. Its physical and chemical properties are well-suited to the transfer of potable water and to the heating field. Above all, the good welding properties and fusion, resulting in a permanent connection, have made the aquatherm PP-R pipe systems and the raw material fusiolen® PP-R well known worldwide.

### Environment

The environmentally friendly material polypropylen fusiolen® PP-R is recyclable and can be ground, melted and reutilised for various applications e.g. motor-protections, wheel linings, laundry baskets and other kinds of transport boxes. There are no polluting substances with PP-R either in its processing or in its disposal.

**Fusiolen® PP-R** – for the benefit of our environment!

### Use of metal deactivators

By adding suitable food-approved additives the risk of a material damage caused by metal under extreme conditions of application is substantially reduced.

### Higher long-term heat stabilization

The long-term heat stabilization has been increased to resist to the potential effects of peak temperatures within higher safety parameters.



### System advantages

System recommended due to its technical advantages: ●

aquatherm green pipe ti   aquatherm blue pipe ti   aquatherm blue pipe ot ti

Application of the system is suitable: ○

<b>Low expansion</b>	●	●	●
<b>Odorless</b>	●		
<b>Corrosionresistant</b>	●	●	●
<b>Very good welding properties</b>	●	●	●
<b>Less pipe friction</b>	●	●	●
<b>High impact resistance</b>	●	●	●
<b>Heat-stability</b>	○	●	●
<b>Metal deactivation</b>	●	●	●
<b>Recyclable</b>	●	●	○
<b>Sound- and heat insulation</b>	●	●	●
<b>Low weight</b>	●	●	●
<b>Self-compensating</b>	●	●	●

## FEATURES

# aquatherm green pipe ti aquatherm blue pipe ti

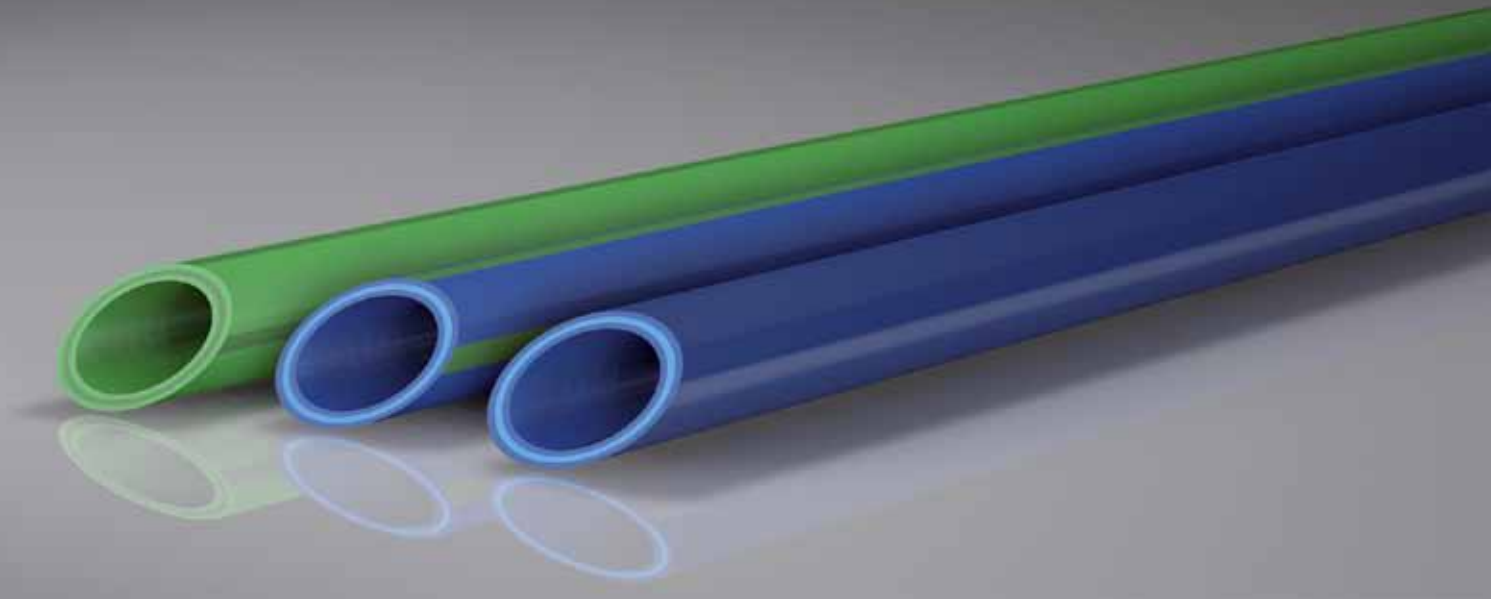

### MEDIUM PIPES

#### aquatherm green pipe ti-faser composite pipe system SDR 9

This pipe system made of fusiolen® PP-R and a special fibre filling, which is in the middle layer of the PP-R, is especially suitable for the installation of potable water pipes.

The favourable, resistant and innovative pipe technology has proven itself **worldwide in 80 countries.**

#### aquatherm blue pipe ti-faser composite pipe system SDR 11/17,6

The aquatherm blue pipe- system has been developed especially for applications outside the potable water installation.

In addition to the general advantages of the PP-R pipe system aquatherm blue pipe in comparison with the aquatherm green pipe-system offers higher volumetric current values due to smaller thickness.





# aquatherm blue pipe ot ti

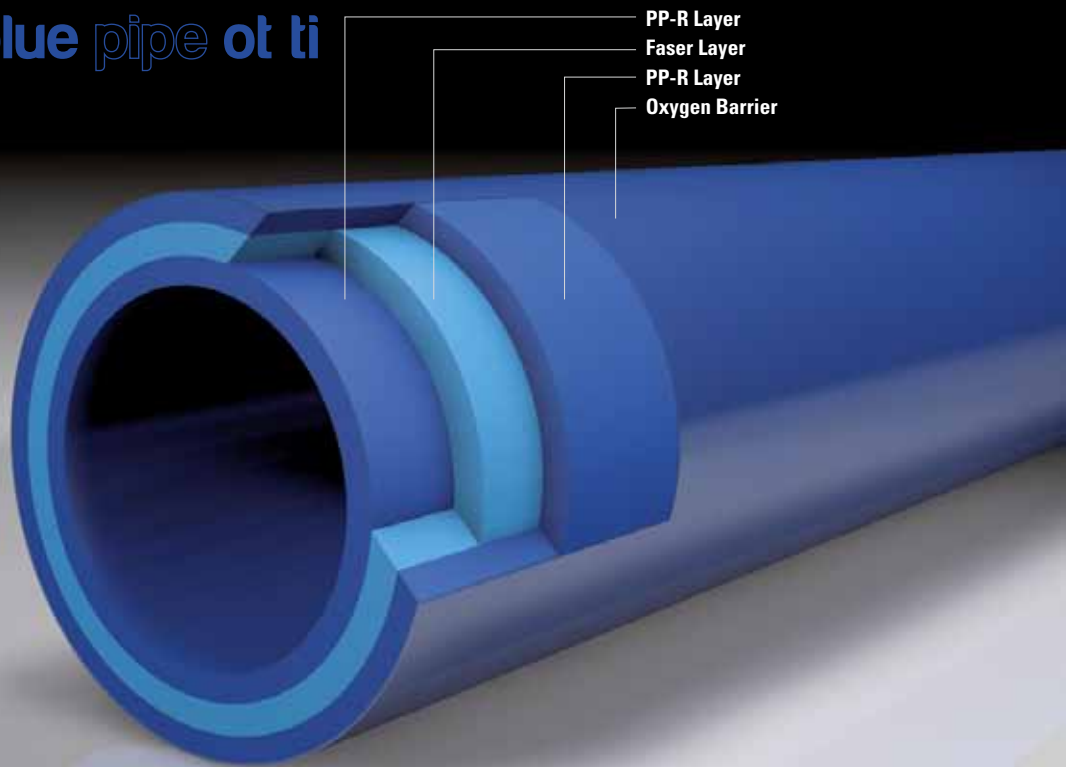

## MEDIUM PIPES

### aquatherm blue pipe ot ti-faser composite pipe system SDR 11

With the newly developed aquatherm blue pipe ot faser composite pipe, aquatherm launches an oxgen-tight pipe, which is equipped with an oxygen barrier and thus corresponds to the requirements of DIN 4726.

The aquatherm blue pipe ot faser composite pipe in combination with the aquatherm green pipe system includes all elements for the pipe installation of chilled, hot fluid and various industrial applications.

### Easy and quick installation technology

aquatherm blue pipe ot faser composite pipes also convinces by easy but effective installation- and connection technology. By heating of pipe and fitting the plastic melts after joining the elements into a permanent connection. aquatherm blue pipe ot faser composite pipes up to 125 mm have to be peeled with peeling tools Art.-No. 50479-50488 before processing.

### Dimensions

medium pipe	aquatherm green pipe ti faser composite pipe SDR 9	aquatherm blue pipe ti faser composite pipe SDR 11	aquatherm blue pipe ot ti faser composite pipe SDR 11	aquatherm blue pipe ti faser composite pipe SDR 17,6	casing pipe
external diameter	dimension	dimension	dimension	dimension	external diameter
32 mm	DN 25	DN 25	DN 25	-	90 mm
40 mm	DN 32	DN 32	DN 32	-	110 mm
50 mm	DN 40	DN 40	DN 40	-	110 mm
63 mm	DN 50	DN 50	DN 50	-	125 mm
75 mm	-	DN 65	DN 65	-	140 mm
90 mm	DN 65	DN 80	DN 80	-	160 mm
110 mm	DN 80	DN 80/100	DN 80/100	-	200 mm
125 mm	DN 100	DN 100	DN 100	-	225 mm
160 mm	DN 125	DN 125	DN 125	DN 150	250 mm
200 mm	DN 150	DN 150	DN 150	DN 200	315 mm
250 mm	DN 200	DN 200	DN 200	DN 250	400 mm
315 mm	DN 250	DN 250	-	DN 300	450 mm

\* larger dimensions on request

## MEDIUM PIPES

### Permissible working pressure

for potable water installations (fluid transported: water acc. to DIN 2000)

Temperature	Service life	aquatherm green pipe SDR 9 MF	
		Permissible working pressure in	
		bar	(psi)
20 °C	1	25,0	(363)
	5	24,2	(351)
	10	23,9	(347)
	25	23,5	(341)
	50	23,1	(335)
30 °C	1	21,7	(315)
	5	21,0	(305)
	10	20,6	(299)
	25	20,2	(293)
	50	20,0	(290)
40 °C	1	18,7	(271)
	5	18,0	(261)
	10	17,7	(257)
	25	17,4	(252)
	50	17,0	(247)
50 °C	1	15,9	(231)
	5	15,3	(222)
	10	15,1	(219)
	25	14,8	(215)
	50	14,5	(210)
60 °C	1	13,5	(196)
	5	13,0	(189)
	10	12,8	(186)
	25	12,5	(181)
	50	12,3	(178)
65 °C	1	12,4	(180)
	5	11,9	(173)
	10	11,7	(170)
	25	11,4	(165)
	50	11,2	(162)
70 °C	1	11,4	(165)
	5	10,9	(158)
	10	10,7	(155)
	25	10,5	(152)
	50	10,3	(149)
50	10,2	(148)	

 Potable water (cold)

 Potable water (hot)

SDR = Standard Dimension Ratio (diameter/wall thickness ratio)  
 MF = multilayer faser  
 MF RP = multilayer faser - raised pressure (resistance)

The determination of the allowable pressures resulted from the specific conditions to which pipe system components in the drinking water domestic installation are exposed to. Limiting factors such as increased flow rates, the use of disinfectants, increased content of oxygen, etc. were considered by the use of the appropriate safety factors. For fittings of butt-welded pipe segments a reduction factor of 0.75 (reduction of the table values by 25%) is effective.

### Permissible working pressure

for general pressure pipe applications outside the fields of application on the adjoining diagram

Temperature	Service life	aquatherm blue pipe SDR 11 MF & MF OT		aquatherm green pipe SDR 9 MF RP		aquatherm blue pipe SDR 17,6 MF	
		Permissible working pressure in					
		bar	psi	bar	psi	bar	psi
10 °C	1	27,8	(403)	28,8	(418)	12,8	(186)
	5	26,2	(380)	27,9	(405)	12,0	(186)
	10	25,6	(372)	27,5	(399)	11,7	(170)
	25	24,7	(358)	27,1	(393)	11,4	(165)
	50	24,1	(350)	26,7	(387)	11,1	(161)
15 °C	1	25,7	(373)	26,9	(390)	11,8	(171)
	5	24,2	(351)	26,0	(377)	11,1	(161)
	10	23,6	(343)	25,7	(373)	10,8	(157)
	25	22,8	(331)	25,2	(366)	10,5	(152)
	50	22,2	(322)	24,9	(361)	10,2	(148)
20 °C	1	23,8	(345)	25,0	(363)	10,9	(158)
	5	22,3	(324)	24,2	(351)	10,3	(149)
	10	21,7	(315)	23,9	(347)	10,0	(145)
	25	21,0	(305)	23,5	(341)	9,6	(139)
	50	20,4	(296)	23,1	(335)	9,4	(136)
30 °C	1	20,2	(293)	21,7	(315)	9,3	(135)
	5	18,9	(274)	20,9	(303)	8,7	(126)
	10	18,4	(267)	20,6	(299)	8,5	(123)
	25	17,8	(258)	20,2	(293)	8,2	(119)
	50	17,3	(251)	19,9	(289)	7,9	(115)
40 °C	1	17,1	(248)	18,6	(270)	7,9	(115)
	5	16,0	(232)	18,0	(261)	7,4	(107)
	10	15,6	(226)	17,7	(257)	7,2	(104)
	25	15,0	(218)	17,3	(251)	6,9	(100)
	50	14,6	(212)	17,1	(248)	6,7	(097)
50 °C	1	14,5	(210)	15,9	(231)	6,7	(097)
	5	13,5	(196)	15,3	(222)	6,2	(090)
	10	13,1	(190)	15,1	(219)	6,0	(087)
	25	12,6	(183)	14,7	(213)	5,8	(084)
	50	12,2	(177)	14,5	(210)	5,6	(081)
60 °C	1	12,2	(177)	13,5	(196)	5,6	(081)
	5	11,4	(165)	13,0	(189)	5,2	(075)
	10	11,0	(160)	12,7	(184)	5,1	(074)
	25	10,6	(154)	12,4	(180)	4,9	(071)
	50	10,3	(149)	12,2	(177)	4,7	(068)
70 °C	1	10,3	(149)	11,3	(164)	4,7	(068)
	5	9,6	(139)	10,9	(158)	4,4	(064)
	10	9,2	(134)	10,7	(155)	4,2	(061)
	25	8,0	(116)	10,4	(151)	3,7	(054)
	50	6,8	(99)	10,2	(148)	3,1	(045)
75 °C	1	9,4	(136)	10,4	(151)	4,3	(062)
	5	8,7	(126)	9,9	(144)	4,0	(058)
	10	8,0	(116)	9,7	(141)	3,7	(054)
	25	6,4	(93)	9,5	(138)	3,0	(044)
	50	5,4	(78)	9,3	(135)	2,5	(036)
80 °C	1	8,6	(125)	9,5	(138)	4,0	(058)
	5	7,7	(112)	9,0	(131)	3,5	(051)
	10	6,5	(94)	8,9	(129)	3,0	(044)
	25	5,2	(75)	8,6	(125)	2,4	(035)
90 °C	1	7,2	(104)	7,8	(113)	3,3	(048)
	5	5,1	(74)	7,4	(107)	2,3	(033)
	10	4,3	(62)	7,3	(106)	2,0	(029)

### Material parameters

Technical Data	PP 80
Melt-flow index 230°C / 2,16 kg	0,3 g/10 min
Elastic modulus	800 N/mm <sup>2</sup>
Yield stress	25 N/mm <sup>2</sup>
Tensile strength	25 MPa
Thermal expansion coefficient	0,15 W/mK (measured at the pipe)
Reynolds-No.	0,007
Inflammability, DIN 4102	B2
oxygen tight (ot pipe)	by oxygen barrier layer, for PE only from -39°C
Medium thermal expansion coeff., K-1, DIN 53752	0,7 · 10 <sup>-4</sup>

### Support intervals

#### aquatherm green pipe li - aquatherm blue pipe li SDR 9/11/17,6

Table to determine support intervals in conjunction with temperature and outside diameter.

Difference in temperature $\Delta T$ [K]	Pipe diameter d (mm)													
	20	25	32	40	50	63	75	90	110	125	160	200	250	315
Support intervals in cm														
0	120	140	160	180	205	230	245	260	290	320	330	335	345	355
20	90	105	120	135	155	175	185	195	215	240	240	275	260	265
30	90	105	120	135	155	175	185	195	210	225	230	240	245	255
40	85	95	110	125	145	165	175	185	200	215	220	230	240	240
50	85	95	110	125	145	165	175	185	190	195	205	220	230	235
60	80	90	105	120	135	155	165	175	180	185	195	205	215	220
70	70	80	95	110	130	145	165	165	170	175	185	195	200	215

Spaces of pipe clamp of vertical pipes can be increased by 20% to the values in the tabel, that means to multiply the tabel values with 1.2.



## INSULATION

### Material

The aquatherm ti pipe systems are insulated with PUR-rigid foam. This polyurethane foam is made of Polyol and Isocyanate and meets the functional requirements of the EN 253. The foam is homogeneous with an average cell size of max. 0,5 mm.

For the professional insulation of the pipe and fitting connections, insulation jackets made of PUR-rigid foam are available for the aquatherm ti pipe system, coated with shrink sockets resulting in a permanent connection with the casing pipes.

### Material parameters

Technical data	PUR
Cell gas Cyclopentane	> 8 %
Core density	> 60 kg/m <sup>3</sup>
Closed cell	> 88 %
Water absorption	< 10 % (Vol)
Compression strength 10 % deformation	> 0.3 N/mm <sup>2</sup>
Shearing resistance	> 0.12 N/mm <sup>2</sup>
Tangent shearing resistance	> 0.20 N/mm <sup>2</sup>
Thermal conductivity at 50° C	< 0.03 W/mK

**LOSS OF HEAT AND COOLING ENGERGY**

Type of pipe	Heat loss at average temperature 40° C in W/m	Heat loss at average temperature 50° C in W/m	Heat loss at average temperature 65° C in W/m
<b>aqualtherm blue pipe and quatherm blue pipe of SDR 11</b>			
32 mm	6.86	8.57	11.14
40 mm	6.92	8.65	11.24
50 mm	8.87	11.08	14.41
63 mm	10.10	12.62	16.41
75 mm	10.99	13.74	17.86
90 mm	11.80	14.75	19.17
110 mm	11.27	14.08	13.81
125 mm	11.43	14.29	18.57
160 mm	14.83	18.54	24.10
200 mm	14.60	15.25	23.73
250 mm	14.15	17.69	23.00
315 mm	18.30	22.88	29.74
<b>aqualtherm green pipe SDR 9 MF RP</b>			
32 mm	6.71	8.38	10.90
40 mm	6.77	8.47	11.01
50 mm	8.62	10.78	14.01
63 mm	9.79	12.24	15.92
75 mm	10.61	13.27	17.25
90 mm	11.38	14.22	18.49
110 mm	10.88	13.59	17.67
125 mm	11.03	13.79	17.93
160 mm	14.17	17.71	23.03
200 mm	13.96	17.44	22.68
250 mm	13.55	16.93	22.02

Type of pipe	Cooling engergy loss at F: -12°C R: -6°C AT: 26°C in W/m	Cooling engergy loss at F: 6°C R: 12°C AT: 26°C in W/m	Cooling engergy loss at F: 15°C R: 18°C AT: 26°C in W/m
<b>aqualtherm blue pipe SDR 11 MF &amp; MF OT</b>			
32 mm	5,88	2,86	1,60
40 mm	5,94	2,89	1,61
50 mm	7,65	3,72	2,08
63 mm	8,75	4,25	2,37
75 mm	9,54	4,64	2,59
90 mm	10,26	4,98	2,79
110 mm	9,80	4,76	2,66
125 mm	9,94	4,83	2,70
160 mm	13,03	6,33	3,54
200 mm	12,81	6,22	3,48
250 mm	12,40	6,02	3,37
315 mm	16,23	7,88	4,41
<b>aqualtherm blue pipe SDR 17,6 MF</b>			
160 mm	13,46	6,54	3,65
200 mm	13,22	6,42	3,59
250 mm	12,79	6,21	3,47
315 mm	16,89	8,21	4,59

F = flow, R = return, AT = ambient temperature

## CASING PIPES

### Material

The casing pipes of the aquatherm ti pipe system are made of the material PE according to DIN EN 8075.

Like insulated steel pipes correspond to the EN 253, aquatherm applies casing pipes, which correspond to the technical requirements of this standard. The material is characterized by the following mechanical and thermal features:

### Material parameters

Technical data	PE 80
Density, g/cm <sup>3</sup> , ISO 1183	0.950
Yield stress, MPa, DIN EN ISO 527	22
Elongation at yield stress, %, DIN EN ISO 527	9
Elongation at break, %, DIN EN ISO 527	300
Tension-E-module, MPa, DIN EN ISO 527	800
Impact strength, kJ/m <sup>2</sup> , DIN EN ISO 179	without break
Impact strength, kJ/m <sup>2</sup> , DIN EN ISO 179	12
Ball impression hardness, MPa, DIN EN ISO 2039-1	40
Shore hardness, D, ISO 868	63
Medium thermal expansion coeff., K-1, DIN 53752	1.8 · 10 <sup>-4</sup>
Thermal conductivity, W/m · K, DIN 52612	0.38
Electric strength, kV/mm, VDE 0303-21	47
Surface resistance, Ohm, DIN IEC 167	10 <sup>14</sup>
Inflammability, DIN 4102	B2
Physiological harmlessness acc. to BgVV	yes
Chemical resistance acc. to DIN 8075 supplement	complied with
Thermal operating conditions	°C -40 to +80

## AQUATHERM TI DATA SHEET

### Dimensions

Medium pipe	Casing pipe	PUR-rigid foam
external diameter	external diameter	thickness
32 mm	90 mm	26.00 mm
40 mm	110 mm	32.00 mm
50 mm	110 mm	27.00 mm
63 mm	125 mm	28.00 mm
75 mm	140 mm	29.50 mm
90 mm	160 mm	32.00 mm
110 mm	200 mm	41.80 mm
125 mm	225 mm	46.50 mm
160 mm	250 mm	41.10 mm
200 mm	315 mm	52.60 mm
250 mm	400 mm	68.70 mm
315 mm	450 mm	60.50 mm

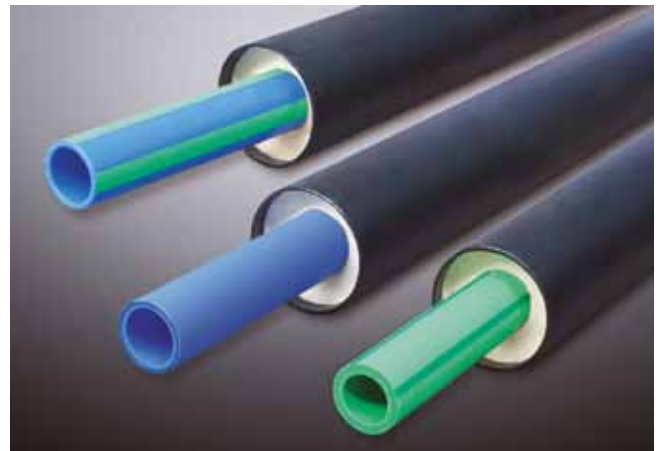

### Pipe data

Pipe dimension		Weight			Water content		
Medium pipe (D <sub>a</sub> )	Casing pipe (D <sub>a</sub> )	aquatherm green pipe ti SDR 9	aquatherm blue pipe ti SDR 11	aquatherm blue pipe ti SDR 17,6	aquatherm green pipe ti SDR 9	aquatherm blue pipe ti SDR 11	aquatherm blue pipe ti SDR 17,6
32 mm	90 mm	1.43 kg/m	1.5 kg/m	-	0.483 l/m	0.539 l/m	-
40 mm	110 mm	1.97 kg/m	2.0 kg/m	-	0.754 l/m	0.834 l/m	-
50 mm	110 mm	2.15 kg/m	2.2 kg/m	-	1.182 l/m	1.307 l/m	-
63 mm	125 mm	2.73 kg/m	2.8 kg/m	-	1.869 l/m	2.074 l/m	-
75 mm	140 mm	3.51 kg/m	3.5 kg/m	-	2.659 l/m	2.959 l/m	-
90 mm	160 mm	4.55 kg/m	4.5 kg/m	-	3.825 l/m	4.252 l/m	-
110 mm	200 mm	6.50 kg/m	6.5 kg/m	-	5.725 l/m	6.359 l/m	-
125 mm	225 mm	8.34 kg/m	8.2 kg/m	-	7.386 l/m	8.199 l/m	-
160 mm	250 mm	11.77 kg/m	11.4 kg/m	9.03 kg/m	12.109 l/m	13.430 l/m	4.67 l/m
200 mm	315 mm	18.80 kg/m	17.9 kg/m	14.22 kg/m	18.908 l/m	21.010 l/m	7.42 l/m
250 mm	400 mm	29.53 kg/m	28.5 kg/m	22.77 kg/m	29.605 l/m	32.861 l/m	12.2 l/m
315 mm	450 mm		40.0 kg/m	31.04 kg/m	46.966 l/m	52.172 l/m	14.3 l/m

## ASSEMBLY OF WELDING TOOLS

The professional processing of aquatherm green pipe ti- and aquatherm blue pipe ti- medium pipes is made by the following tools for the connection of insulated pipes and fittings by socket welding or by butt-welding.

### IMPORTANT!

Only use the original aquatherm welding devices and aquatherm welding tools, except devices and tools which are especially approved by aquatherm.

1. aquatherm - manual welding device (800 W) without welding tools (Art.-No. 50337) for medium pipes of dimension 32 – 63 mm
2. aquatherm - manual welding device (1400W) without welding tools (Art.-No. 50341) for medium pipes of dimension 32 – 125 mm
3. aquatherm - welding tools for manual welding devices

Art.-No. 50212	32 mm
Art.-No. 50214	40 mm
Art.-No. 50216	50 mm
Art.-No. 50218	63 mm
Art.-No. 50220	75 mm
Art.-No. 50222	90 mm
Art.-No. 50224	110 mm
Art.-No. 50226	125 mm

4. aquatherm - welding machine (1400W) and welding tools 50 – 125 mm (Art.-No. 50347) for medium pipes of dimension 50 – 125 mm
5. aquatherm - butt-welding-machines for medium pipes of dimension 160 – 630 mm



Manual welding device 800W with welding tools 32 – 63 mm



Manual welding device 1400W with welding tools 32 – 125 mm

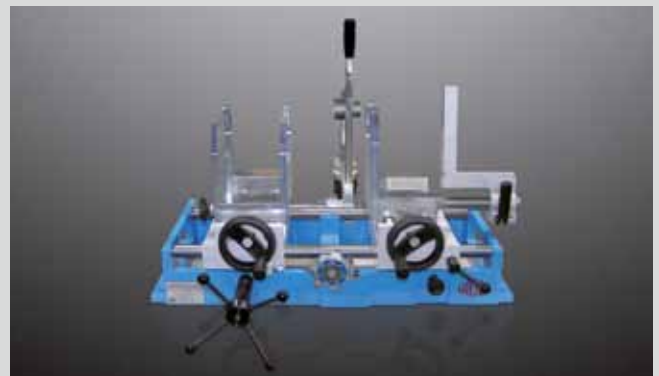

Welding machine



Butt-welding machine type Light and accessories



- 6. aquatherm - electrical welding jig Art.-No. 50159 for medium pipes of dimension 63 -125 mm

**NOTE:**

Just for the processing of aquatherm blue pipe or ti- medium pipes of dimension 32-125 mm, which are connected by socket welding, the following tools must be applied in addition. Before welding, the oxygen barrier layer at the pipe ends must be removed with these tools, as described on pages 22 and 23.

- 7. aquatherm Universal Peeling Tools

Art.-Nr. 50481	32 mm
Art.-Nr. 50482	40 mm
Art.-Nr. 50483	50 mm
Art.-Nr. 50484	63 mm
Art.-Nr. 50485	75 mm
Art.-Nr. 50486	90 mm
Art.-Nr. 50487	110 mm
Art.-Nr. 50488	125 mm

**Instructions for the assembly of welding tools!**

- The heating plate of the welding device must be in good order and condition.
- External damages like scratches or grooves and impurities must be removed.
- The welding tools, consisting of 2 elements (male and female), must be free from damages and must be checked for cleanliness before processing.
- If required, both parts of the tools must be cleaned with a non fibrous, coarse tissue and optionally with spirit.
- Damaged tools generally must not be used. They must be exchanged.
- Screw on the cold welding tools manually and tighten the screw hand-tight with the Allan key.
- Welding tools must fully touch the welding plate and must not overlap the edge.



**PART A: HEATING UP PHASE / HANDLING**

**Temperature pilot lamp (yellow)**  
glows constantly while the heat-up phase and blinks, when the welding temperature is achieved

**Operating lamp (green)**  
glows constantly, as soon as the device is connected with the power supply system



**HEATING-UP PHASE / HANDLING**

**Part A: Heating-up phase**

1. Plug the welding device and control if the yellow pilot lamp glows.
2. Dependent on the size of the welding tools and the ambient temperature the heating up of the tools takes between 10 and 30 minutes.
3. During the heating up phase the tools must be tightened close by turning the screw with an Allan key.

Take care that the welding tools fully contact the welding plate. Never use pliers or any other unsuitable tools, as this will damage the coating of the welding tools.

4. A temperature of 260° C is required for welding the aquatherm ti medium pipes. According to DVS- Welding Guidelines the welding temperature must be checked at the tools before welding. The temperature control is made by a fast indicating surface thermometer.

**ATTENTION:**

**First welding: 5 minutes after achieving the welding temperature!**

**Part A: Handling**

5. A tool change at a heated device requires another check of the welding temperature at the new tool after its heating up
6. If the device has been unplugged, e. g. during longer breaks, the heating up process must be restarted (from item 1)
7. After finishing the welding works unplug the welding device and let it cool down.

Never use water or other liquids to cool the welding device as this destroys the heating resistances! Never open the welding devices or repair them by yourself. Return the defective devices for repair to aquatherm.

8. Welding devices and welding tools must be protected from moisture and impurities. Burnt particles may cause an incorrect fusion. The application of damaged and dirty tools is not allowed.
9. Before and after the welding do not lay the welding device on the welding tools as the Teflon coating of the tools may be damaged. Always put the device in the included stand.

## TECHNICAL REGULATIONS AND DATA

### Part A: Technical regulations

For the correct handling of welding machines the General Regulations for Protection of Labour and Prevention of Accidents must be observed. Particularly the Regulations of the Employers' Liability Insurance Association of the Chemical Industry regarding Machines for the Processing of Plastics (Chapter: Welding Machines and Welding Equipment) are effective.

For the handling of aquatherm green pipe-welding machines, devices and tools please the General Regulations DVS 2208, part 1 are still valid.

For the appropriate and professional handling with the tools and accessories the manufacturer's instructions must be observed.

### Part A: Fusion data

Pipe external-Ø	Welding depth	Heating time		Welding time	Cooling time
		sec. DVS	sec. AQE*		
mm	mm			sec.	min.
32	18.0	8	12	6	4
40	20.5	12	18	6	4
50	23.5	18	27	6	4
63	27.5	24	36	8	6
75	30.0	30	45	8	8
90	33.0	40	60	8	8
110	37.0	50	75	10	8
125	40.0	60	90	10	8

On the basis of the DVS 2207, Part 11 the heating time should be increased by 50% if the ambient temperature is below + 5° C

\*heating times recommended by aquatherm

#### Dimension 160 - 315 mm:

These dimensions are joined by butt-welding.

**The General Guidelines for Heated Tool Welding acc. to DVS 2207 Part 11 are applied hereupon.**

### Advice regarding butt-welding of medium pipes of dimensions 160 – 315 mm

The standard data concerning butt-welding depend on the pipe dimensions and devices. They are available in the processing description enclosed to the machines or they can be required directly at aquatherm.

## NOTES FOR PREPARATION

### Control of welding temperature

The welding temperature must be checked at all welding devices and machines with a fast indicating thermometer. The measurement is made directly at the tools.

The temperature measurement is always made in the beginning of each welding. If the required welding temperature is not achieved, the welding connection may be incorrect.

### Welding temperatures for aquatherm ti

Heating element socket welding: 260°C for medium pipes of dimension 32 - 125 mm

Heating element butt-welding: 210°C for medium pipes of dimension 160 - 315 mm



Measurement of temperature at the aquatherm- manual welding device (800W )



Measurement of temperature at the aquatherm- manual welding device (1400W )



Measurement of temperature at the aquatherm- welding machine



Measurement of temperature at the aquatherm- butt-welding machine

## Cutting and skinning of pipes



1. Measure the pipe length and mark on the casing pipe.



2. Mark the cutting line with an adhesive tape around the pipe.



3. Cut the pipe with a customary handsaw with a saw blade for plastic along the cutting line.



4. Mark the skinning length of 22.5 cm from the pipe end on the casing pipe.



5. Cut the casing pipe with the pipe cutter up to the PUR-insulation layer around the whole pipe.



6. Slit the casing up to the PUR-insulation layer with a customary handsaw for plastic.



7. Detach the end of the casing pipe and then remove the PUR-insulation layer mechanically on the full skinning length.



8. Clean the skinned medium pipe and deburr the pipe ends inside and outside.

## NOTES FOR PREPARATION

### Removal of oxygen barrier layer of aquatherm blue pipe ot ti for dimensions 32 – 250 mm

#### Attention – Do not forget the shrink sleeve!

For pipe and/or fitting connections, which should be insulated with an aquatherm ti socket or reduced socket, take note that the shrink sleeve must be pushed over one side of the connection before the welding process.

But do not remove the release liner protecting the shrink sleeve. The subsequent application of the shrink sleeve is not possible.

By using the aquatherm universal peeling tools the end pieces of the aquatherm blue pipe OT (and UV) can be peeled. By the uniform removal of the outer layer of the pipe any extension of the pipe system by fitting is possible. The universal peeling tools are available in the sizes Ø 20-Ø 125 mm (Art.-No. 50479 – 50488). The peeling process is done either mechanically or manually. For the mechanical processing two attachment plates for pipe sizes Ø20-Ø63 mm (Art.-No. 50499) and Ø75-Ø125 mm (Art.-No. 50500) are available. The power drill should have a high torque.

### 1. INSTRUCTIONS FOR THE MECHANICAL PEELING PROCESS

**1.1.** The attachment plate is clamped with the hexagon bolt in the power drill.

**1.2.** The peeler is fixed with its screws in the slot matching the diameter of the attachment plate and rotated clockwise so that the peeler adheres to the attachment plate.

**1.3.** The peeling tool clamped on the chuck is set by the lead to the end of the pipe.

**1.4.** The peeling process starts with rotation of the peeling tool upon slight force in axial direction. The peeling operation is completed when the attachment plate strikes against the pipe end.

**1.5.** The pipe now can be welded by socket welding method.

### 2. PEELING INSTRUCTIONS FOR MANUAL PEELING

**2.1.** For the manual peeling two handles are mounted at the peeling tool.

**2.2.** The peeling tool is pushed onto the untreated pipe up to the stop.

**2.3.** The peeling tool is turned clockwise as long as the marked peeling depth (see table) is reached.

**2.4.** If the specified/marked peeling depth (see table) is reached, the peeling tool is removed and the socket welding process can start. If the electric socket can be used as a sliding sleeve, the peeling depth for the electric socket welding (see table) must be doubled.

**TABLE OF PEELING DEPTH: SOCKET WELDING**

Diameter	Peeling depth
ø 20	16 mm
ø 25	20 mm
ø 32	22 mm
ø 40	25 mm
ø 50	28 mm
ø 63	32 mm
ø 75	34 mm
ø 90	37 mm
ø 110	42 mm
ø 125	44 mm





## HEATING-ELEMENT SOCKET WELDING WITH THE MANUAL WELDING DEVICE

### Welding process without mechanical support



Remove dirt and impurities at the pipe ends. (Note: for the processing of aquatherm blue pipe of ti, also see description on page 22)



After the heating time pull off the welding socket and the pipe end from the welding tools.



Mark welding depth with the attached blue template and a pencil.



Directly after the removal of the welding device push the socket on the pipe end.



Take the aquatherm-socket out of the packing. Loose fittings must be cleaned.



Within the processing time press the welding socket on the pipe end up to the end of the welding depth.



Press the aquatherm-socket on the male welding tool and at the same time push the pipe end up to the marked welding depth in the female welding tool.



Align and momentary fix the welding socket. Further processing is carried out after the specified cooling time.



## HEATING-ELEMENT SOCKET WELDING WITH MANUAL WELDING DEVICE AND ELECTRIC WELDING JIG

### Welding process with mechanical support



1. Adjust pipe slide in the back guide rail to the required pipe dimension and fix with locking bow.



2. Adjust fitting slide in the front guide rail to the required pipe dimension and fix with locking bow.



3. Push clamping jaws against the face side of the fitting up to the stop and tighten them with a fixing screw.



4. The welding depth and the clamping distance are marked by the aquatherm-clamping template (blue) in one work.



5. Pull the pipe end up to the end of the clamping mark into the welding jig and tighten the clamping jaws with the fixing screw.



6. Remove dirt and impurities from the pipe end and from the inside of the fitting.



7. Position the manual welding device in the center of fitting and pipe end and drive together the welding jig slowly.

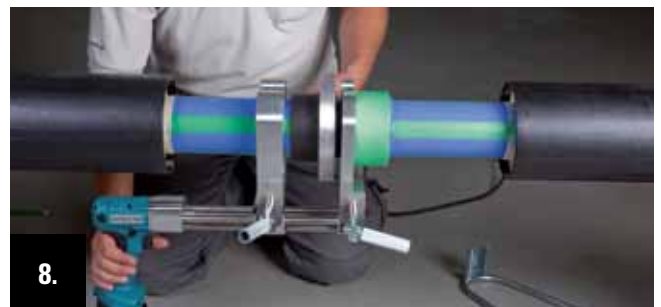

8. The male welding tool is pressed in the welding socket with the welding jig and at the same time the pipe end is pushed up to the marked welding depth in the female socket.

**Welding process with mechanical support**



9. After the end of the heating period drive the welding jig apart and remove the welding device between pipe end and fitting.



13. After the cooling time release the clamping jaws on the pipe side by unscrewing the fixing screw.



10. Immediate after removal of the welding device the welding jig is driven together slowly and evenly.



14. Drive the welding jig apart to release the fixing screw of the fitting clamping jaw.



11. Press the pipe end, within the processing time, with the welding jig up to the end of the welding depth in the welding socket.



15. Release the clamping jaws on the fitting side by unscrewing the fixing jaw.

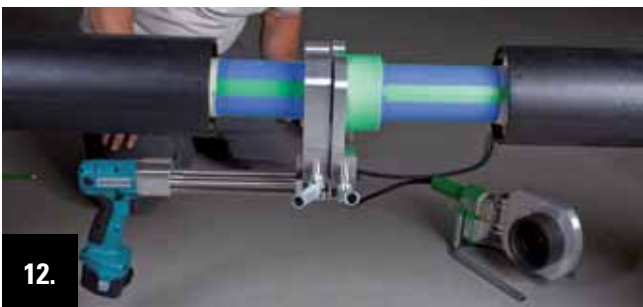

12. Align the welding connection with the welding jig and fix it shortly. The further processing is proceeded after the specified cooling time.



16. Open the clamping jaws of the welding jig as far that the welding jig can be removed sidewise or downward from the connection.

## HEATING-ELEMENT SOCKET WELDING WITH THE WELDING MACHINE

### Preparing and welding process



1. Position and align the welding machine. Regard the required place! (Consider that the machine must be removed below the pipeline after finishing the welding works.)



5. Hold the welding socket between the fitting clamping jaws and press it against the stops at the face side.



2. Plug the machine and check, if the yellow operation lamp is on.



6. Fix the socket close to the stop und tighten the clamping jaws with the crank handle.



3. The welding depth of the required pipe dimension is adjusted by the turning button, which is at the left face side of the machine frame.

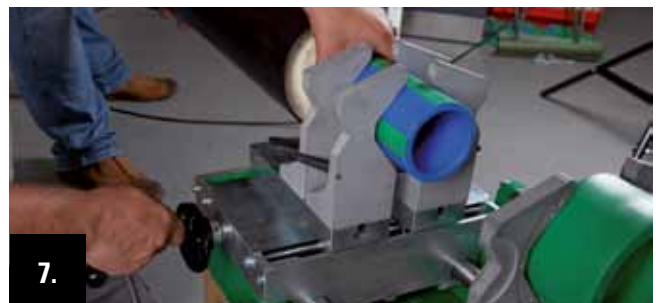

7. Push the pipe end between the clamping jaws and center it by turning the crank handle, but do not screw firmly.



4. For pipe fixing push the back pair of clamping jaws at the front pair of clamping jaws and fix it by tightening of the fixing screws.



8. For adjustment of the welding depth press the calibration button in the middle of the machine frame up to the stop.



Preparing and welding process



9.

Drive the welding machine slide with the crank handle together and press the pipe end against the welding socket.



13.

Fold down the welding device and drive together the slide of the welding machine with the crank handle.

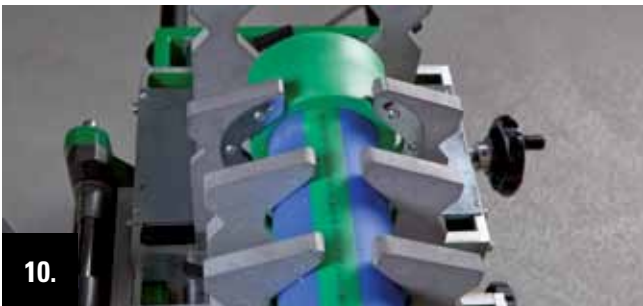

10.

Align the pipe end circumferentially at the welding socket and center the position exactly.



14.

After the heating time drive apart the welding machine slide with the crank handle and raise the welding device.



11.

Fix the pipe end with the clamping jaws by turning the crank handle.



15.

Drive together the welding machine slide with the crank handle up to the stop.



12.

Drive apart the slide of the welding machine with the crank handle and pull out the calibration button for adjusting the welding depth.



16.

After the cooling time release the clamping jaws at the fitting and at the pipe end and turn the welding machine by 180°.

## HEATING-ELEMENT BUTT-WELDING WITH THE BUTT-WELDING MACHINE TYPE: LIGHT

### Preparation of pipe ends and fusion



1.

Arrange and align the welding machine, plug in the hose of the hydraulics and energize the welding device and milling cutter.



5.

Switch on the milling cutter and drive up the pipe ends slowly in the machine slide to the milling cutter by operating the hydraulic system.

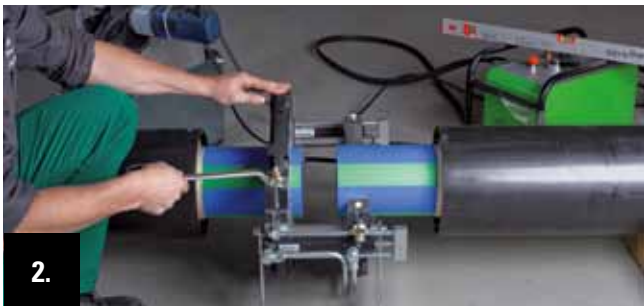

2.

Place the first pipe end in the in the mounting clamps. Align it with the upper mounting clamp and fix it.



6.

By using the hydraulic system the pipe ends are milled plane at the face side with light pressure to the milling cutter.

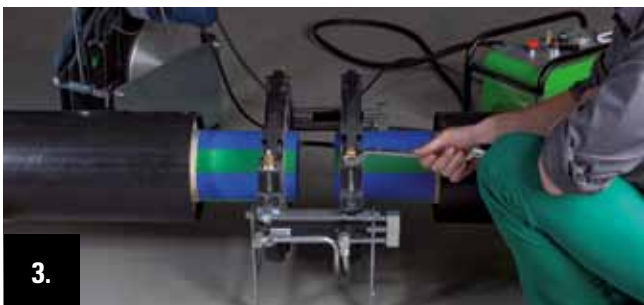

3.

Place the other pipe end in the same way in the mounting clamps, align and fix it with the mounting clamp.



7.

If the milling flake is circumferentially, drive apart the machine slide, take the milling cutter away and remove the debris.



4.

Insert the milling cutter between the pipe ends and fix it with the locking at the frame of the machine slide. The power-on of the tool only works with correct locking.



8.

Drive the machine slide slowly together again. The pipe ends must fit planar. Control clearance and then adjust the pressure at the hydraulic system in accordance with the data sheet.



**Preparation of pipe ends and fusion**

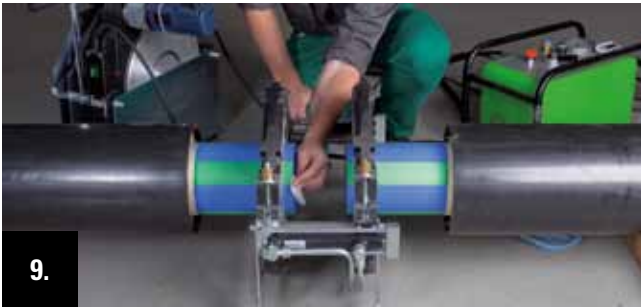

9. Clean the pipe ends at the face sides.

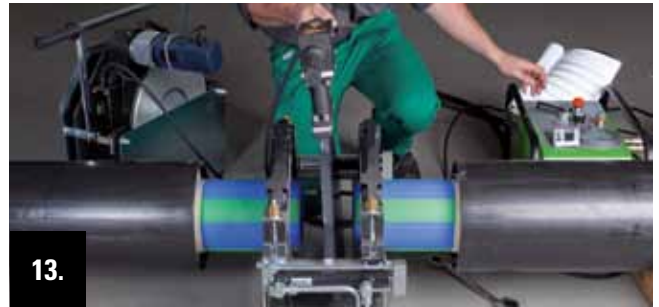

13. After the end of the heating period drive apart the machine slide speedily by using the hydraulic system. Then remove the welding plate.



10. Insert the welding device between the pipe ends. Check, if the welding plate is clean and measure the welding temperature.



14. By using the hydraulic system the pipe ends are joined slowly until the required welding pressure is achieved.



11. Drive the machine slide, by operating the hydraulic system, slowly against the welding plate. Then press the pipe ends until the predetermined adjustment pressure is achieved against the welding plate.

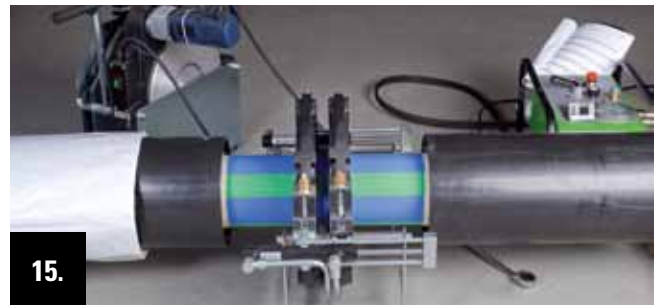

15. The adjusted welding pressure remains on the machine slide up to the end of the cooling period.



12. After the bead has achieved the preset height the pressure is reduced at the hydraulic system. Then the heating up phase starts. Now the face sides in which the face sides of the pipe ends are heated up to the required welding temperature.



16. After the end of the cooling period the pressure is released at the hydraulic system. Then the mounting clamps are disconnected and the clamping device is removed.



The winder shown below is not necessarily required for the processing of the MONO TOP 40 corrosion protective tape.

## MONO TOP 40 FOR POST ENVELOPING

### without and with winder

The MONO TOP 40 is an especially strong self-welding corrosion protective tape with a very flexible plastic layer outside.

The following material is required for the post enveloping of the aquatherm ti insulation-socket set with MONO TOP 40 corrosion protective tape:

1. Adhesive tape for fixing the PUR-half shell elements
2. Emery cloth of graining 40 or 60
3. Winder for MONO TOP 40 corrosion protective tape (not necessarily required)
4. MONO TOP 40 corrosion protective tape (see on the winder)
5. Primer for etching the KM-pipe surface.
6. Cutter knife for cutting the MONO TOP 40 corrosion protective tape after finishing the winding process.
7. Flat curved brush (distributes the primer well and can be used horizontally – also good for narrow lines and corners).

For the pre-arrangement, please execute the steps 1 – 16 on page 25 -30 (depending on application) and the steps 1.2 – 2.3 on page 40/41.

After finishing these processing steps follow the below described processing guidelines.



### 1.

#### Fixing of the PUR-half shell elements

The PUR-half shell elements are placed around the medium pipe by key and slot technique (insulation shells are numbered on the surface) and fixed with adhesive tape.



**2. Marking of the enveloping KM-pipe**

Max. distance for locating the first winding of the MONO TOP 40 corrosion protective tape from the end of the KM-pipe: 100 mm.

Min. distance for locating the first winding of the MONO TOP 40 corrosion protective tape from the end of the KM-pipe: 50 mm.

A white felt-tip pen is especially suitable.

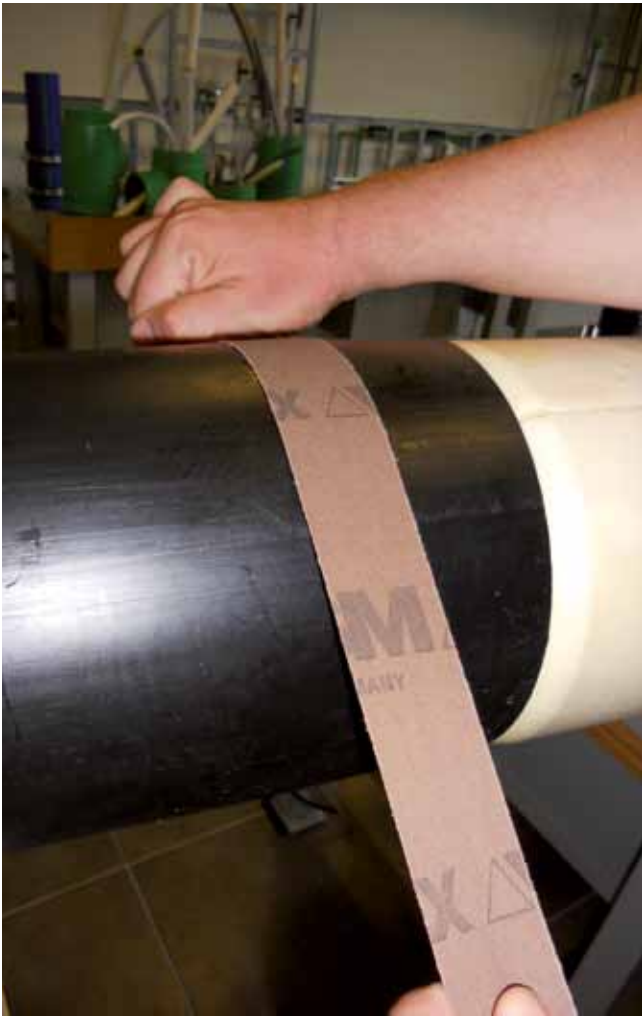

**3. Roughen of the enveloping surface of the KM-pipe**

The roughening of the KM-pipe surface is for a better bonding of the MONO TOP 40 tape at the KM-pipe and for the removal of little impurities. For roughening the surface of the KM-pipe an emery cloth of graining 40 or 60 should be applied. This working process must be repeated at the opposite end of the KM-pipe.



**4. Cleaning of the sealing surface**

Please clean the KM-pipe ends, roughened with emery cloths on both sides, with Tangit-cleaning cloths or with ethanol/spirit (min. 99,9 %) and a white, dry, grease-and lint free cloth.





#### 5. **Brushing of the primer**

Brush the dry area, which has to be enveloped (KM-pipe and PUR-half shell elements) with primer evenly thin and completely (see step 6). Here a curved flat brush is used.

When decanting the primer in a suitable bin, it can also be applied with a small paint roller.

Before processing the primer installation guidelines are to be read on the back of the packing and followed.



#### 6. **Brushing of the primer**



#### 7. **Brushing of the primer**

Upon completion of this step, the primer must be allowed to evaporate for at least 10 min. Then necessarily determine by touching, whether the primer has dried.

If the airing time is more than 4 hours, the KM-pipe and the PUR-rigid foam elements must again be coated with primer.



#### 8. **Attaching of the MONO TOP 40 corrosion protection tape**

Prior to attaching the MONO TOP 40 corrosion protection tape, the release film is to be removed at the bottom. Attach the MONO TOP 40 corrosion protective tape to the marking, in the position of 3 or 9 o'clock.



**9.  
Fixing of the MONO TOP 40 corrosion protection tape**

Wrap the first winding of the MONO TOP 40 corrosion protection tape with an equal ly strong tension around the KM-pipe.



**10.  
Fixing of the MONO TOP 40 corrosion protection tape**



**11.  
Fixing of the MONO TOP 40 corrosion protection pipe**

The second winding of the MONO TOP 40 corrosion protective tape is wound spirally around the KM pipe with a minimum 50% overlap. It is important to ensure that the release film is removed evenly.



**12.  
Fixing of the MONO TOP 40 corrosion protection pipe**

**13.****Finished winding**

After completion of the enveloping the MONO Top 40 corrosion protection tape is cut with a sharp knife, and firmly pressed with the palm.

**1.****Processing with the winding machine**

Insertion of the MONO TOP 40 corrosion protection tape. Here, the corrosion protection tape MONO TOP 40 is pushed onto the central roll and the release film is laced onto the outer small roll in the designated slot.



Then the winding machine is adjusted.

The large adjusting screw in the center of the winding machine is used to adjust the tension compression. The small lower screw is used to adjust the winding radius.

The following setting calculation can be taken as a basis:

1. Loosen the screw
2. All 4 wheels must touch the base evenly
3. Now the diameter of the KM-pipe is divided by 20, for example  $160 \text{ mm KM-pipe} / 20 = 8 \text{ mm}$
4. The distance between base and one of the wheels should be about 8 mm.
5. Now the screw is hand-tightened.



Then step 9 – 19 are repeated.





## CORROSION PROTECTIVE TAPES

Corrosion protective tapes are specially designed for high-quality post enveloping of pipes. The material is easy, quick and safe to process at the welding seams bows and fittings. The systems meet the requirements of the DIN 30672 resp. EN 12068 and are DVGW approved.

<b>MonoTop40</b> One tape system	Load class acc. to EN 12068/DIN 30672 B/30	DVGW-Reg.-No: <b>NV-5180BQ0144</b>
<b>MonoTop40</b> , 1 x 50% overlapping <b>Primer P27</b> Total thickness 2,03 mm	System for post enveloping of welding seams, complete pipelines, but especially for bows and fittings up to DN 600. Due to the high flexibility best suitable for manual handling without winder. Mono Top40 is an especially strong self-welding corrosion protection tape with a very flexible plastic outside layer.	
Supporting material		
Adhesive		



### Technical Data

Corrosion protection pipe Mono Top 40

Adhesive base	butyl rubber mixture
Base of carrying tape	Polyolefins
Colour	black
Total thickness	1,016 mm
Adhesive thickness inside	0,610 mm
Carrier thickness	0,406 mm

**test method** DIN EN 12068

Tensile strength	7 N/mm
Elongation of break	400%
Core diameter	76 mm

Adhesion

to primer coated steel at 23° C	20 N/10 mm
to primer coated steel at 50° C	3 N/10 mm
to itself	20 N/10 mm

**test method** DIN EN 12068

Enveloping resistance	40 KV/mm
Water absorption*	0,60%

Processing temperature**	-35 up to 70°C
Permanent operating temperature	-35 up to 85°C

\*measurement with on steel adhesive tape

\*\* temperature of tape minim. 10°C

### Demand Mono Top 40

for aquatherm-district heating pipes

Pipe DN (SDR 11)	Casing pipe DA in mm	Width of envelopin- gin mm	Recomm. width MonoTop40	per m MonoTop40	Area for priming in sqm
DN 25	90	650	50	7,35	0,184
DN 32	110	650	50	8,98	0,225
DN 40	110	650	50	8,98	0,225
DN 50	125	650	50	10,21	0,255
DN 65	140	650	50	11,44	0,286
DN 80	160	650	50	13,07	0,327
DN 80 / 100	200	650	50	16,34	0,408
DN 100	225	650	50	18,38	0,459
DN 125	250	650	100	10,21	0,510
DN 150	315	650	100	12,86	0,643
DN 200	400	650	100	16,34	0,816
DN 250	450	650	100	18,38	0,918

### Technical data

Primer

Features	Test method	Unit	Typ PSI P27
Colour			black
Density	ASTM 1298	g/cm <sup>3</sup>	0,83
Solvent content	ISO 1515	%	27
Viscosity (4 mm needle)	ASTM D 1200	sec.	35
Burning point	ABEL IP 170	°C	-12
Consumption		l/m <sup>2</sup>	approx. 0,2 ℓ
Operating temperature		°C	-30 up to 60

## AQUATHERM TI-SOCKET

### Product specification

The aquatherm ti-socket is a cross-linked heat shrinkable casing system for half-shell joint protection of pre-insulated pipes. This socket is full length shrinkable and is mainly applied in combination with PUR-half-shell technology. The aquatherm ti-socket consists of the following articles which are supplied in a set as one packing unit:

- 1 pc shrink sleeve
- 1 pc casing shrink film
- 1 pc casing shrink film
- 2 pcs PUR –rigid foam insulation element type 1
- 2 pcs PUR – rigid foam insulation element type 2
- 1 pc PP-R welding socket  
(for medium-pipes of dimension 32-125 mm only)
- 2 pcs tension tape  
(only for casing pipes of the dimension 300 mm and more)

The aquatherm ti-socket PLA consists of the following articles, which are supplied as a set in one packing unit:

- 1 Pc shrink sleeve
- 2 Pcs PUR rigid foam insulation element type 1
- 2 Pcs PUR rigid foam insulation element type 2
- 1 Pc PP-R-welding socket  
(only for medium pipes of dimension 32 - 125 mm)

All components must be protected from impurities and humidity before and during the processing.

### Storage and safety

To ensure maximum performance, store aquatherm ISO socket in a dry, ventilated area. Keep products sealed in original cartons and avoid exposure to direct sunlight, rain, snow, dust or other adverse environmental conditions. Avoid storage at temperatures above 80° C or below – 20 °C. Product installation should be made in accordance with local health and safety regulations.

### Equipment list for processing

Tools, required for the further processing of the aquatherm ti socket:

- Propane tank with hose, torch and regulator
- Grease and lint-free rag
- Marking pen free from grease
- Ethanol /Spirit (mind. 99,9 %)
- Sandpaper (40-60 grade)
- Measuring tape, knife, cutter, press roll, hard hat, triangular scraper, concave rasp
- Temperature measuring device with contact sensor
- Wooden wedges
- Assembly carrier truck



aquatherm ti-socket CSC-X



aquatherm ti-socket PLA

**SHRINK SLEEVE SYSTEM**

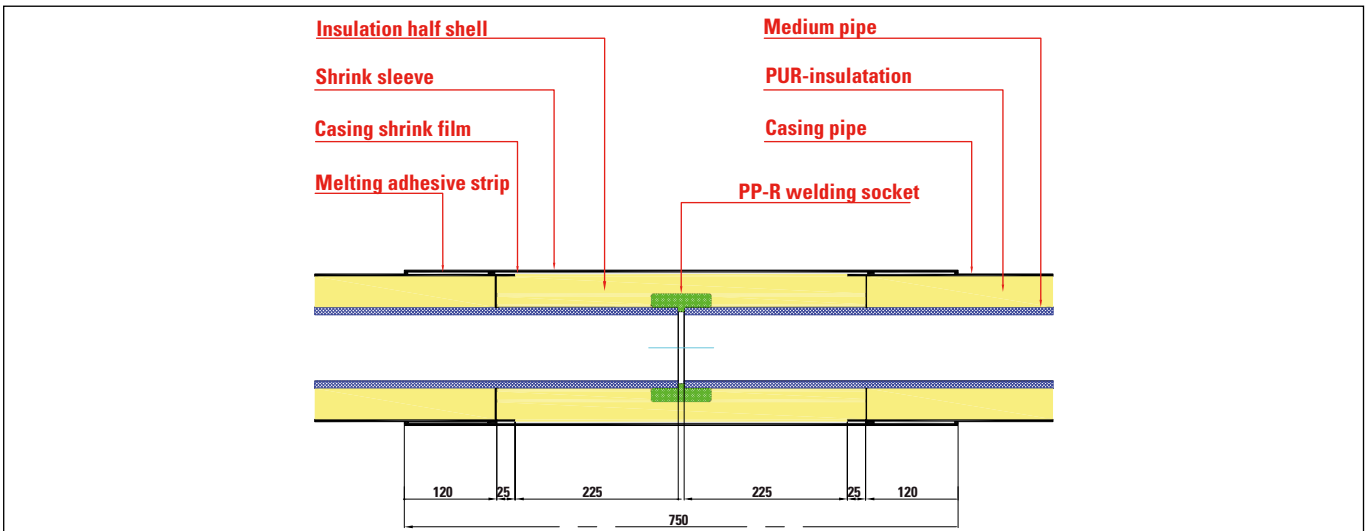

aquatherm ti-socket

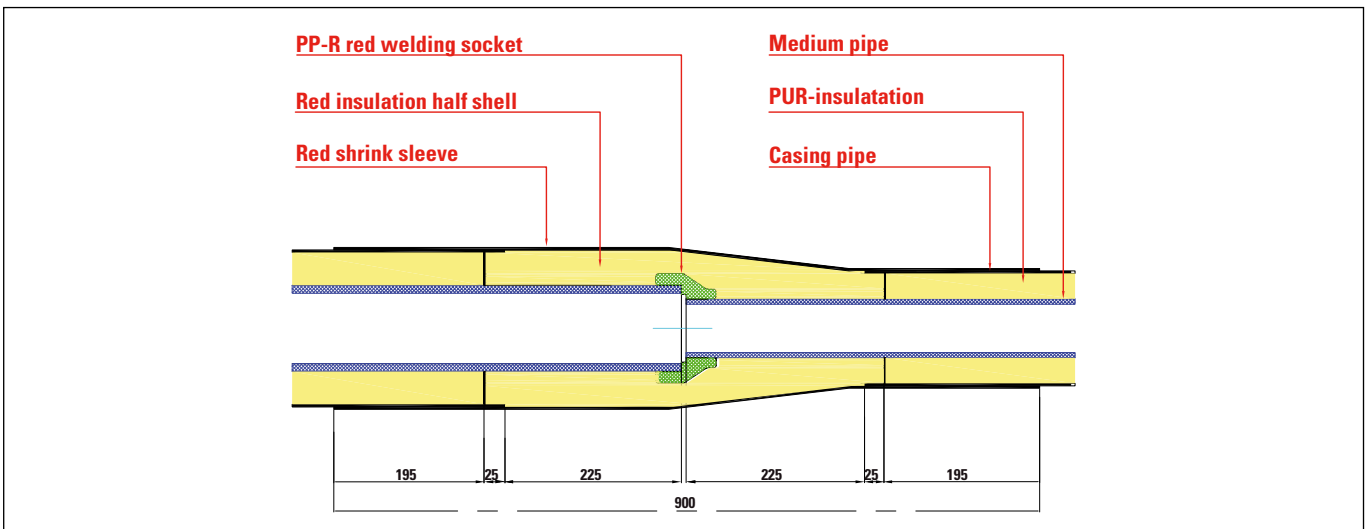

aquatherm ti-red-socket

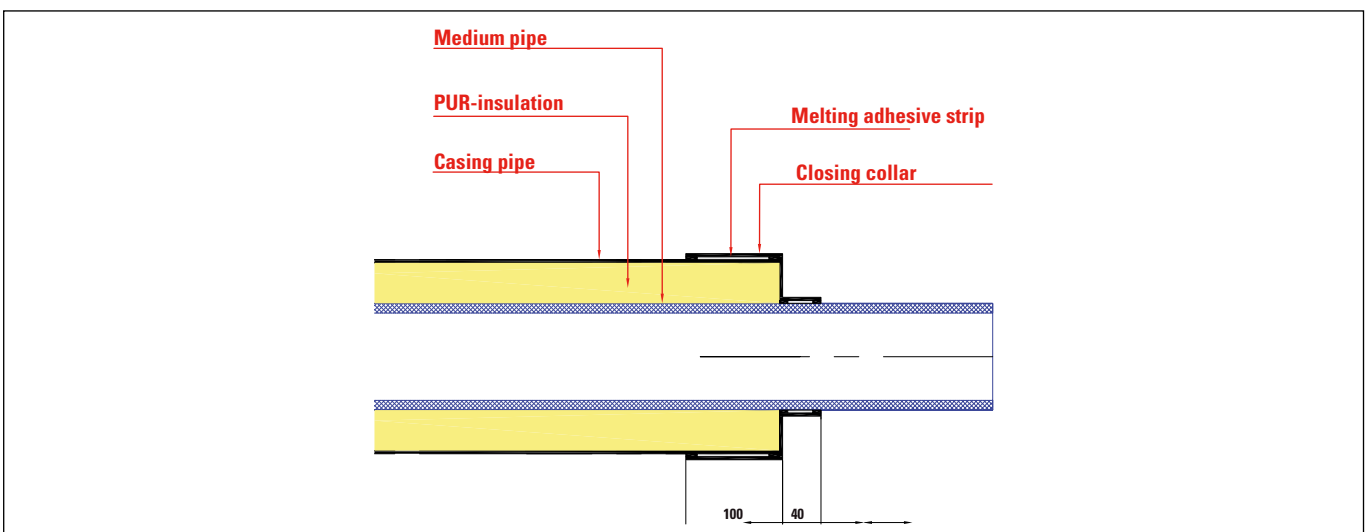

aquatherm ti-closing collar



## AQUATHERM TI-SOCKET

### Backfilling trench

Correct conditions of the trench must be checked before starting the installation of the district pipeline. The digging of the excavation works must be placed in a way that the installation is not obstructed.

For a professional installation of the aquatherm ti-sockets in the trench, ensure that there is adequate work space area around the pipe in the backfilling trench. The trench bottom must be free from water and sludge. The pipe laying must meet the requirements.

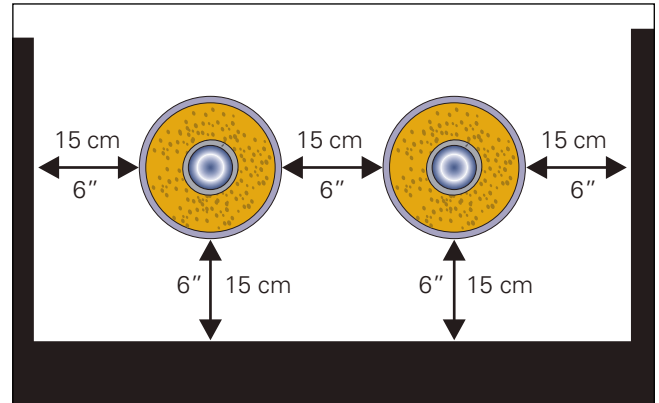

Place requirement

### Flame intensity

Adjust the flame according to the outside conditions.

- Use weak yellow flame for thin-walled casing pipe and shrink products, at still air, high outside temperatures and less space in the trench (A)
- Use moderate blue flame for thick-walled casing pipes and shrink products for high wind and low temperatures (B)

Always aim the torch perpendicular to the casing shrink film and shrink sleeve. Move in circumferential direction quickly around the jacket pipe. Do not overheat the casing pipe because there is a risk of burning the PE-casing pipe.

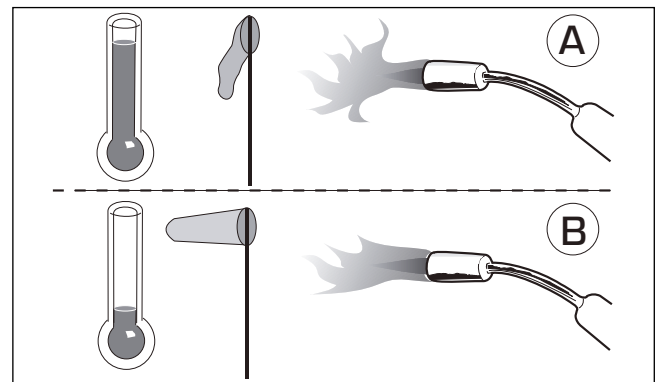

Advices for handling with propane gas torch

### 1. Casing preparation

1.1 Before connecting the medium pipe and the socket by socket welding respectively by butt-welding, the shrink sleeve must be pulled over one of the both pipe ends. The white protective foil must not be removed yet! During the welding of the medium pipe the shrink sleeve must be protected from burning.

1.2 Dry and clean the whole socket area and all sealing areas from loose impurities with a propane torch and a dry grease and lint-free rag.

1.3 Remove any wet PUR foam from the end of the pre-insulated pipe. The cut should be made with a suitable saw - planar-vertical as possible – to ease the later adjustment of the insulation half shells.

1.4 Remove any burrs and dirt from **all** sealing areas with a triangular scraper or a concave rasp.





## AQUATHERM TI-SOCKET

### 2. Insulation half-shell installation

The insulation half-shells must be adjusted as possible without gaps and without pressing.



2.1

2.1 Each with number 1 and 2 marked insulation half-shells is mutually pushed into the cavity at the face sides of the casing pipes. Then they are joined parallel in direction of the medium pipe and turned to the bottom side of the medium pipe.



3.1

### 3. Marking of shrink sleeve position

3.1 For determination of the same overlap on both sides of the casing pipes, the shrink sleeve must be pushed to one end of the casing pipe. Then the end of the shrink sleeve is marked on the other side of the casing pipe.



2.2

2.2 Now the other both insulation half-shells marked with number 1 and 2 are inserted as described under 2.1. The key and slot joint of all elements allows a gap-free and custom-fit joining of all shell-elements.



3.2

3.2 Push back the shrink sleeve so far in direction of the starting position that the marking of step 3.1 becomes visible. Meter the distance between marking and leading edge of the casing pipe and mark center distance.



2.3

2.3 An additional fixing of the insulation half-shells is made by a customary adhesive tape in the middle.



3.3

3.3 Pass the dimension of center distance on the casing pipe on the opposite side and mark it also.

2.4 Clean the surface of all sealing areas with a rag to remove dirt and degrease the areas with ethanol (min. 99,9 %) by using a grease and lint-free rag.

## AQUATHERM TI-SOCKET

### 4. Preparation of the seal areas



4.1 Roughen the surface of the casing pipe end complete circumferentially up to the marking by using sandpaper (40 to 60 grade).

4.2 Repeat the working process of step 4.1 also at the other end of the casing pipe.



4.3 Use a dry, grease and lint-free rag with ethanol/spirit (min. 99,9 %) or Tangit cleaning wipes to clean the roughened surface of the casing pipe ends.



### 5. Assembly of melting adhesive strips

5.1 Heat the cleaned pipe end with a low flame on each side of the pipe up to approximately 80 °C.



5.2 Remove the thinner release liner at the underlap of the melting adhesive strip.



5.3 Attach the melting adhesive strip at the end of the casing pipe in a distance of approx. 30 mm to the marking of the center distance in a 90 °C angle to the pipe axis and wrap around closely.



5.4 Remove the thick release liner on the top side of the melting adhesive strip only in the overlapping area at the beginning of the melting adhesive strip. Gently heat the end of the melting adhesive strip at the bottom side. Then tightly wrap the heated film around the pipe and press it close in the overlapping area.

## AQUATHERM TI-SOCKET



5.5

5.5 Repeat the described work process of step 5.1 to 5.4 at the other end of the casing pipe.



5.6

5.6 Wrap outwards the upper release liner on both sides in a 45 ° angle that the beginning of the film of both melting adhesive strips protrudes over the marking of the center distance.



6.1

### 6. Assembly of casing shrink film

6.1 Remove the release liner at the bottom of the casing shrink film. Center the film over the PUR- insulation sleeve in a 90 °C angle to the pipe axis and wrap closely around the PUR –insulation sleeves. A sufficient overlap of the shrink film of at least 10 cm is important. On both ends the shrink film must overlap the casing pipes with at least 2.5 cm.



6.2

6.2 Gently heat the end of the shrink film at the bottom side – like the melting adhesive strips. Then wrap the heated part around the pipe and press it tight in the overlap area.

Before installation check the following:

- film is in full contact with the PUR insulation sleeves and the casing pipe ends
- casing shrink film conforms to the PUR insulation sleeves
- no cracks or holes in film backing

In general the casing shrink film will shrink during the shrink sleeve application, however, the film can be heated gently in advance to remove any wrinkling or to improve profile conformance.

## AQUATHERM TI-SOCKET

### 7. Positioning of the shrink sleeve



7.1

7.1 Push the shrink sleeve as far to the marking of the center distance on the other side of the casing pipe until the marking is visible on both sides of the center distance.



7.4

7.4 Pull off the release liner of the melting adhesive strip and remove it.



7.2

7.2 Cut the release liner with a knife from the outside in a way that the release liner in the inside of the shrink sleeve can also be pulled out from one side.



7.5

7.5 Pull off the release liner of the melting adhesive strip on the other side and remove it. Check the position of the shrink sleeve according to the markings of the center distance on both sides of the casing pipes.



7.3

7.3 Pull out the release liner from one side and remove it completely. Position the shrink sleeve in a way that the quality-control number is in the area between "10 and 14 o'clock position".



## 8. Shrinking sequence

8.1 - 8.5 Check the position of the shrink sleeve and the cleanliness in the whole processing area again.

For the processing of the ISO-socket of dimension 315 mm and higher it is advisable for economic and mounting reasons to work with two assemblers and two propane gas torches.

The shrinking process starts at one side of the shrink sleeve. Consider that the shrink sleeve is heated up with a weak propane gas flame (see page 39). The burner head must be swayed slowly around the pipe. **Especially regard the area between "5 and 7 o'clock position".**

The shrinking process must be continued by controlled, spiral forward motions of the burner head around the pipe –form a funnel to avoid air bubbles - and is completed at the other end of the shrink sleeve.

## Quality control – "finger test"

During the shrinking process check the "weakness" of the shrink sleeve base and the liquefaction of the hot-melt adhesive in the sealing area by a "finger test". Still existing cold zones can be reheated without any difficulty.

When the shrink sleeve lays evenly tight and without gaps completely around the PUR-insulation jacket respectively around the casing pipes the shrinking process can be finished.





### 9. Processing of the tension tape

The ends of the shrink sleeves for casing pipes with a diameter of 300 mm and more must be fixed with the tension tape (in the installation kit) directly after finishing the shrinking process.

### 10. Quality control by “finger tip test”

Upon completion of the shrinking process a simple “**finger tip test**” can ensure that the ends of the shrink sleeve do not bent up at any point of the sealing area. If so this area can be reheated.

### 11. Final control

Upon completion of the above specified work processes the following must be assured:

- The shrink sleeve lays evenly tight and completely around the PUR-insulation jackets and the PE-casing pipes on the whole length.
- The hot-melt adhesive is visible at the outline.
- No cold areas or damages at the shrink sleeve base.

### Recommendations

The time between the end of the aquatherm ti-socket processing and the start of the sand back-filling of the pre-insulated aquatherm ti-system elements should be at least 0.5 – 1.0 hour.

The shrinkable base material and the hot-melt adhesive must be cooled down sufficiently and hardened so that the required protection and the peel strength are achieved and a permanent tightness is guaranteed.

### Elements / System review

**For all aquatherm ti pipe systems the following system elements are available:**

- pipes (6 m and 12 m lengths)
- bows 45°
- bows 90°
- branches
- reduces branches
- cross-over branches
- reduced cross-over branches
  
- ISO shrink sleeve
- ISO reduced shrink sleeve
- ISO closing collar
  
- special fittings on request
  
- Compact seals

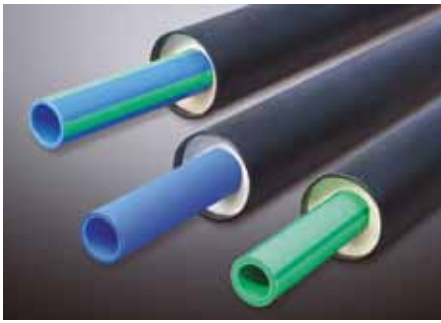

**aquatherm ti - FASER COMPOSITE PIPES**

faser composite pipe , length á 5,8 m with PUR rigid foam and coated with a casing pipe made of PEHD

Outside diameter		System								PU	Box unit
		aquatherm green pipe ti SDR 9		aquatherm blue pipe ti SDR 11		aquatherm blue pipe ot ti SDR 11		aquatherm blue pipe ti SDR 17,6			
Medium pipe	Casing pipe	Art.-No.	Price € m/pc	Art.-No.	Price € m/pc	Art.-No.	Price € m/pc	Art.-No.	Price € m/pc	m/pc	
32 mm	90 mm	1370711		2270111		2470711				5,8	10
40 mm	110 mm	1370713		2270113		2470113				5,8	10
50 mm	110 mm	1370715		2270115		2470115				5,8	10
63 mm	125 mm	1370717		2270117		2470117				5,8	10
75 mm	140 mm	1370719		2270119		2470119				5,8	10
90 mm	160 mm	1370721		2270121		2470121				5,8	10
110 mm	200 mm	1370723		2270123		2470123				5,8	10
125 mm	225 mm	1370725		2270125		2470125				5,8	10
160 mm	250 mm	1370729		2270129		2470129		2770129		5,8	10
200 mm	315 mm	1370733		2270133		2470133		2770133		5,8	10
250 mm	400 mm	1370737		2270137		2470137		2770137		5,8	10
315 mm	450 mm			2270141				2770141		5,8	10

On request available: aquatherm green pipe ti SDR7,4

**aquatherm ti - FASER COMPOSITE PIPES**

faser composite pipe , length á 11,6 m with PUR rigid foam and coated with a casing pipe made of PEHD

Outside diameter		System								PU	Box unit
		aquatherm green pipe ti SDR 9		aquatherm blue pipe ti SDR 11		aquatherm blue pipe ot ti SDR 11		aquatherm blue pipe ti SDR 17,6			
Medium pipe	Casing pipe	Art.-No.	Price € m/pc	Art.-No.	Price € m/pc	Art.-No.	Price € m/pc	Art.-No.	Price € m/pc	m/pc	
32 mm	90 mm	1370712		2270112		2470712				11,6	10
40 mm	110 mm	1370714		2270114		2470114				11,6	10
50 mm	110 mm	1370716		2270116		2470116				11,6	10
63 mm	125 mm	1370718		2270118		2470118				11,6	10
75 mm	140 mm	1370720		2270120		2470120				11,6	10
90 mm	160 mm	1370722		2270122		2470122				11,6	10
110 mm	200 mm	1370724		2270124		2470124				11,6	10
125 mm	225 mm	1370726		2270126		2470126				11,6	10
160 mm	250 mm	1370730		2270130		2470130		2770130		11,6	10
200 mm	315 mm	1370734		2270134		2470134		2770134		11,6	10
250 mm	400 mm	1370738		2270138		2470138		2770138		11,6	10
315 mm	450 mm			2270142				2770142		11,6	10

On request available: aquatherm green pipe ti SDR7,4

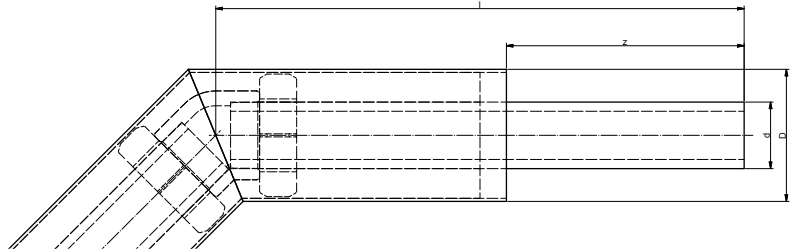
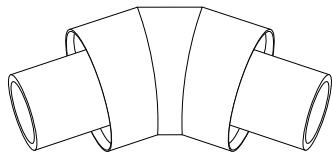

**aquatherm ti - ELBOW 45° SL 500**

with PUR rigid foam and coated with a casing pipe made of PEHD

Outside diameter		z	l	System								PU	Box unit
d Medium pipe	D Casing pipe			aquatherm green pipe ti SDR 9		aquatherm blue pipe ti SDR 11		aquatherm blue pipe ot ti SDR 11		aquatherm blue pipe ti SDR 17,6			
d	D	z	l	Art.-No.	Price € m/pc	Art.-No.	Price € m/pc	Art.-No.	Price € m/pc	Art.-No.	Price € m/pc	m/pc	
32	90,00	225,00	500,00	1312512		2212512		2412512				1	10
40	110,00	225,00	500,00	1312514		2212514		2412514				1	10
50	110,00	225,00	500,00	1312516		2212516		2412516				1	10
63	125,00	225,00	500,00	1312518		2212518		2412518				1	10
75	140,00	225,00	500,00	1312520		2212520		2412520				1	10
90	160,00	225,00	500,00	1312522		2212522		2412522				1	10
110	200,00	225,00	500,00	1312524		2212524		2412524				1	10
125	225,00	225,00	500,00	1312526		2212526		2412526				1	10
160	250,00	225,00	500,00	1312530		2212531		2412531		2712530		1	10
200	315,00	225,00	500,00	1312534		2212535		2412535		2712534		1	10
250	400,00	225,00	500,00	1312538		2212539		2412539		2712538		1	10
315	450,00	225,00	500,00			2212543				2712542		1	10

Also available in design 15° and 30°

On request available: aquatherm green pipe ti SDR7,4

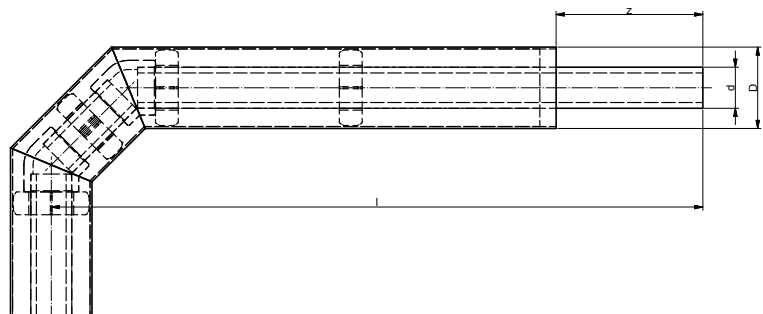
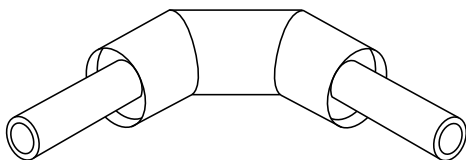

**aquatherm ti - ELBOW 90° SL 500**

with PUR rigid foam and coated with a casing pipe made of PEHD

Outside diameter		z	l	System						PU	Box unit
d Medium pipe	D Casing pipe			aquatherm green pipe ti SDR 9		aquatherm blue pipe ti SDR 11		aquatherm blue pipe ot ti SDR 11			
d	D	z	l	Art.-No.	Price € m/pc	Art.-No.	Price € m/pc	Art.-No.	Price € m/pc	m/pc	
32	90,00	225,00	500,00	1312212		2212212		2412212		1	10
40	110,00	225,00	500,00	1312214		2212214		2412214		1	10
50	110,00	225,00	500,00	1312216		2212216		2412216		1	10
63	125,00	225,00	500,00	1312218		2212218		2412218		1	10
75	140,00	225,00	500,00	1312220		2212220		2412220		1	10

Also available in design 60° and 75°

On request available: aquatherm green pipe ti SDR7,4

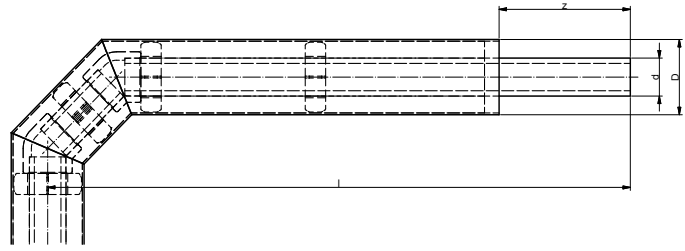
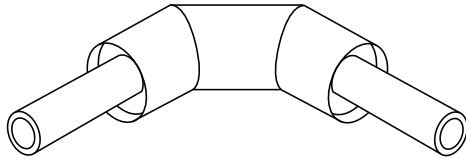

### aquatherm ti - ELBOW 90° SL 1000

with PUR rigid foam and coated with a casing pipe made of PEHD

Outside diameter		System										LE	PG
d	D			aquatherm green pipe ti SDR 9		aquatherm blue pipe ti SDR 11		aquatherm blue pipe ot ti SDR 11		aquatherm blue pipe ti SDR 17,6			
Medium pipe	Casing pipe	z	l	Art.-No.	Price € m/pc	Art.-No.	Price € m/pc	Art.-No.	Price € m/pc	Art.-No.	Price € m/pc	m/pc	
32	90,00	225,00	1000,00	1312112		2212112		2412112				1	10
40	110,00	225,00	1000,00	1312114		2212114		2412114				1	10
50	110,00	225,00	1000,00	1312116		2212116		2412116				1	10
63	125,00	225,00	1000,00	1312118		2212118		2412118				1	10
75	140,00	225,00	1000,00	1312120		2212120		2412120				1	10
90	160,00	225,00	1000,00	1312122		2212122		2412122				1	10
110	200,00	225,00	1000,00	1312124		2212124		2412124				1	10
125	225,00	225,00	1000,00	1312126		2212126		2412126				1	10
160	250,00	225,00	1000,00	1312130		2212131		2412131		2712130		1	10
200	315,00	225,00	1000,00	1312134		2212135		2412135		2712134		1	10
250	400,00	225,00	1000,00	1312138		2212139		2412139		2712138		1	10
315	450,00	225,00	1000,00			2212143				2712142		1	10

Also available in design 60° and 75°

On request available: aquatherm green pipe ti SDR7,4

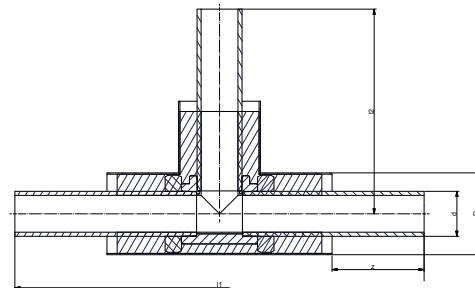
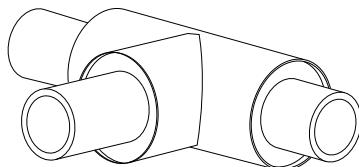

### aquatherm ti - BRANCH

with PUR rigid foam and coated with a casing pipe made of PEHD

Outside diameter		System										PU	Box unit	
d	D			aquatherm green pipe ti SDR 9		aquatherm blue pipe ti SDR 11		aquatherm blue pipe ot ti SDR 11		aquatherm blue pipe ti SDR 17,6				
Medium pipe	Casing pipe	z	l1	l2	Art.-No.	Price € m/pc	Art.-No.	Price € m/pc	Art.-No.	Price € m/pc	Art.-No.	Price € m/pc	m/pc	
32	90,00	225,00	1000	500,00	1313112		2213112		2413112				1	10
40	110,00	225,00	1000	500,00	1313114		2213114		2413114				1	10
50	110,00	225,00	1000	500,00	1313116		2213116		2413116				1	10
63	125,00	225,00	1000	500,00	1313118		2213118		2413118				1	10
75	140,00	225,00	1000	500,00	1313120		2213120		2413120				1	10
90	160,00	225,00	1000	500,00	1313122		2213122		2413122				1	10
110	200,00	225,00	1000	500,00	1313124		2213124		2413124				1	10
125	225,00	225,00	1000	500,00	1313126		2213126		2413126				1	10
160	250,00	225,00	1000	500,00	1313130		2213131		2413131		2713130		1	10
200	315,00	225,00	1500	750,00	1313134		2213135		2413135		2713134		1	10
250	400,00	225,00	1500	750,00	1313138		2213139		2413139		2713138		1	10
315	450,00	225,00	1500	750,00			2213143				2713142		1	10

On request available: aquatherm green pipe ti SDR7,4

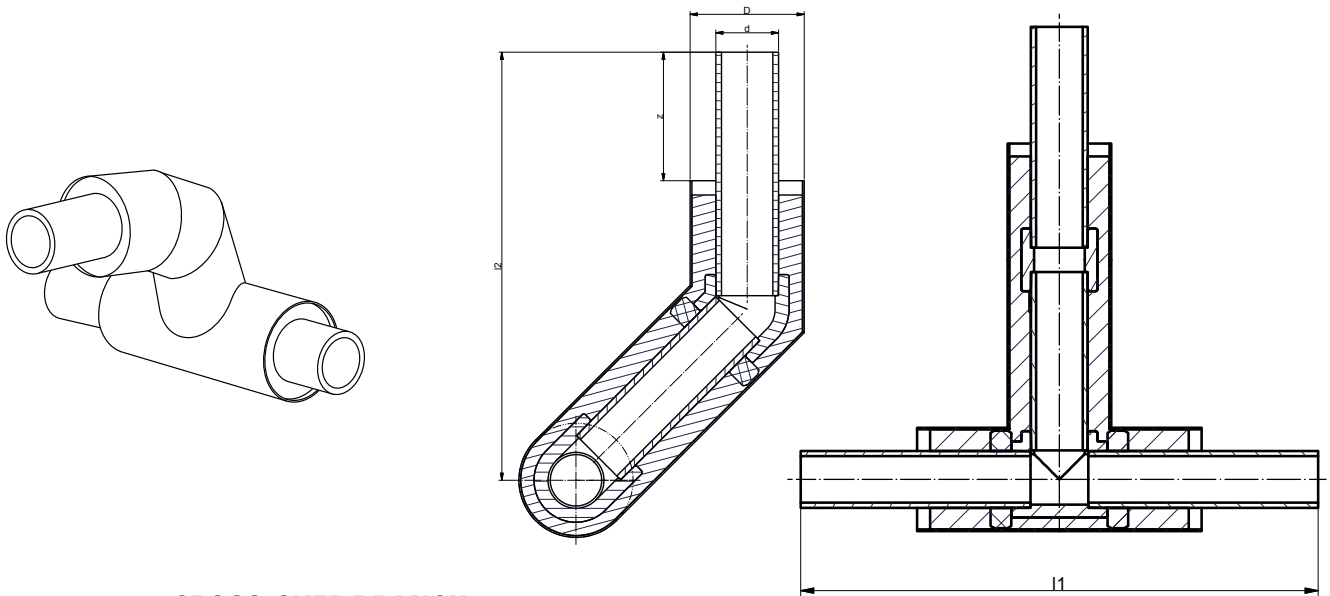

**aquatherm ti - CROSS-OVER BRANCH**

with PUR rigid foam and coated with a casing pipe made of PEHD

Outside diameter		z	l1	l2	System								PU	Box unit
d Medium pipe	D Casing pipe				aquatherm green pipe ti SDR 9		aquatherm blue pipe ti SDR 11		aquatherm blue pipe ot ti SDR 11		aquatherm blue pipe ti SDR 17,6			
Art.-No.	Price € m/pc	Art.-No.	Price € m/pc	Art.-No.	Price € m/pc	Art.-No.	Price € m/pc	Art.-No.	Price € m/pc	m/pc				
32	90,00	225,00	1000	750,00	1318112		2218112		2418112				1	
40	110,00	225,00	1000	750,00	1318114		2218114		2418114				1	
50	110,00	225,00	1000	750,00	1318116		2218116		2418116				1	
63	125,00	225,00	1000	750,00	1318118		2218118		2418118				1	
75	140,00	225,00	1000	750,00	1318120		2218120		2418120				1	
90	160,00	225,00	1000	750,00	1318122		2218122		2418122				1	
110	200,00	225,00	1000	750,00	1318124		2218124		2418124				1	
125	225,00	225,00	1000	750,00	1318126		2218126		2418126				1	
160	250,00	225,00	1000	1000,00	1318130		2218131		2418131		2718130		1	10
200	315,00	225,00	1500	1000,00	1318134		2218135		2418135		2718134		1	10
250	400,00	225,00	1500	1000,00	1318138		2218139		2418139		2718138		1	10
315	450,00	225,00	1500	1250,00			2218143				2718142		1	10

On request available: aquatherm green pipe ti SDR7,4



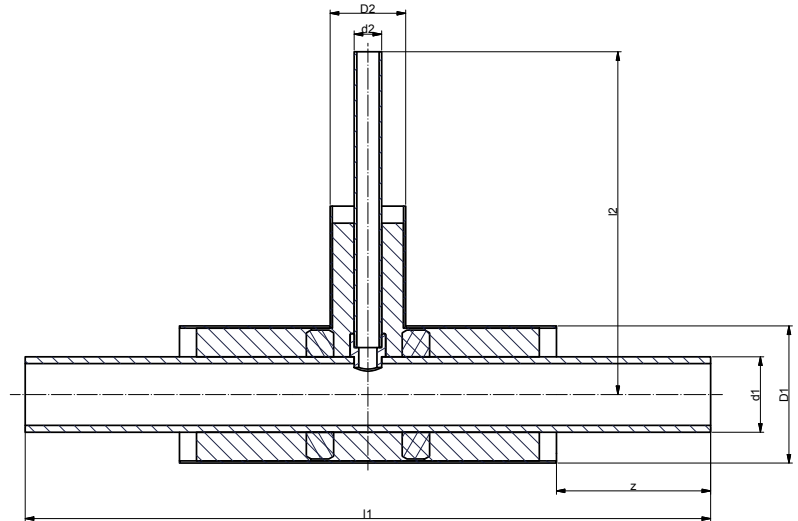
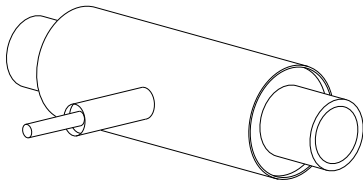

### aquatherm ti - RED.-BRANCH SL 500

with PUR rigid foam and coated with a casing pipe made of PEHD

Outside diameter							System								PU	Box unit
d1 Me- dium pipe	d2 Me- dium pipe	D1 Casing pipe	D2 Casing pipe	z	l1	l2	aquatherm green pipe ti SDR 9	Price € m/pc	aquatherm blue pipe ti SDR 11	Price € m/pc	aquatherm blue pipe ot ti SDR 11	Price € m/pc	aquatherm blue pipe ti SDR 17,6	Price € m/pc		
40	32	110,00	90,00	225,00	1000	500,00	1313202		2213202		2413202				1	
50	32	110,00	90,00	225,00	1000	500,00	1313206		2213206		2413206				1	
50	40	110,00	110,00	225,00	1000	500,00	1313208		2213208		2413208				1	
63	32	125,00	90,00	225,00	1000	500,00	1313212		2213212		2413212				1	
63	40	125,00	110,00	225,00	1000	500,00	1313214		2213214		2413214				1	
63	50	125,00	110,00	225,00	1000	500,00	1313216		2213216		2413216				1	
75	32	140,00	90,00	225,00	1000	500,00	1313220		2213220		2413220				1	
75	40	140,00	110,00	225,00	1000	500,00	1313222		2213222		2413222				1	
75	50	140,00	110,00	225,00	1000	500,00	1313224		2213224		2413224				1	
75	63	140,00	125,00	225,00	1000	500,00	1313226		2213226		2413226				1	
90	32	160,00	90,00	225,00	1000	500,00	1313230		2213230		2413230				1	
90	40	160,00	110,00	225,00	1000	500,00	1313232		2213232		2413232				1	
90	50	160,00	110,00	225,00	1000	500,00	1313234		2213234		2413234				1	
90	63	160,00	125,00	225,00	1000	500,00	1313236		2213236		2413236				1	
90	75	160,00	140,00	225,00	1000	500,00	1313238		2213238		2413238				1	
110	32	200,00	90,00	225,00	1000	500,00	1313242		2213242		2413242				1	
110	40	200,00	110,00	225,00	1000	500,00	1313244		2213244		2413244				1	
110	50	200,00	110,00	225,00	1000	500,00	1313246		2213246		2413246				1	
110	63	200,00	125,00	225,00	1000	500,00	1313248		2213248		2413248				1	
110	75	200,00	140,00	225,00	1000	500,00	1313250		2213250		2413250				1	
110	90	200,00	160,00	225,00	1000	500,00	1313252		2213252		2413252				1	
125	32	225,00	90,00	225,00	1000	500,00	1313256		2213256		2413256				1	
125	40	225,00	110,00	225,00	1000	500,00	1313258		2213258		2413258				1	
125	50	225,00	110,00	225,00	1000	500,00	1313260		2213260		2413260				1	
125	63	225,00	125,00	225,00	1000	500,00	1313262		2213262		2413262				1	
125	75	225,00	140,00	225,00	1000	500,00	1313264		2213264		2413264				1	
125	90	225,00	160,00	225,00	1000	500,00	1313266		2213266		2413266				1	
125	110	225,00	200,00	225,00	1000	500,00	1313268		2213268		2413268				1	
160	32	250,00	90,00	225,00	1000	500,00	1313290		2213291		2413291		2713290		1	
160	40	250,00	110,00	225,00	1000	500,00	1313292		2213293		2413293		2713292		1	
160	50	250,00	110,00	225,00	1000	500,00	1313294		2213295		2413295		2713294		1	
160	63	250,00	125,00	225,00	1000	500,00	1313296		2213297		2413297		2713296		1	
160	75	250,00	140,00	225,00	1000	500,00	1313298		2213299		2413299		2713298		1	
160	90	250,00	160,00	225,00	1000	500,00	1313300		2213301		2413301		2713300		1	
160	110	250,00	200,00	225,00	1500,00	750,00	1313302		2213303		2413303		2713302		1	10
160	125	250,00	225,00	225,00	1500,00	750,00	1313304		2213305		2413305		2713304		1	10

On request available: aquatherm green pipe ti SDR7,4

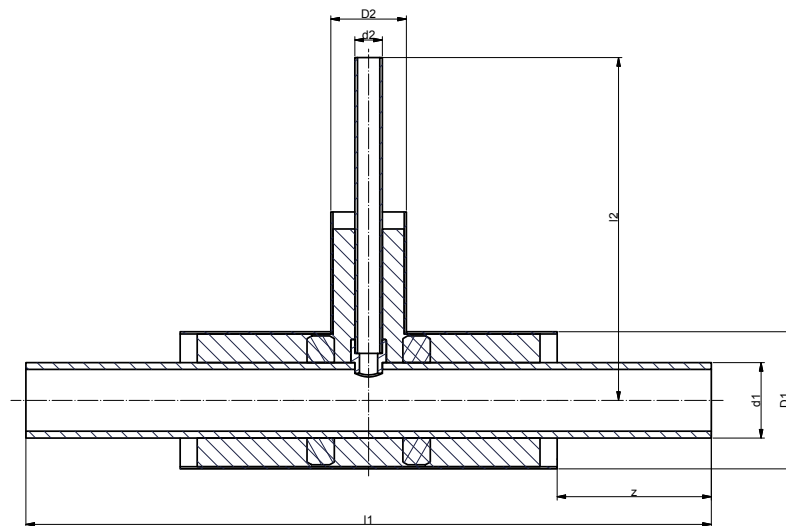
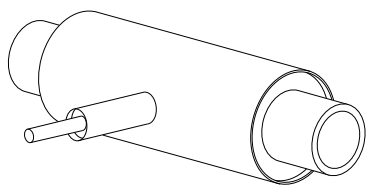

### aquatherm ti - RED.-BRANCH SL 750

with PUR rigid foam and coated with a casing pipe made of PEHD

Outside diameter				System							PU	Box unit				
d1 Medium pipe	d2 Medium pipe	D1 Casing pipe	D2 Casing pipe	z	l1	l2	aquatherm green pipe ti SDR 9	aquatherm blue pipe ti SDR 11	aquatherm blue pipe ot ti SDR 11	aquatherm blue pipe ti SDR 17,6						
Art.-No.	Price € m/pc	Art.-No.	Price € m/pc	Art.-No.	Price € m/pc	Art.-No.	Price € m/pc	Art.-No.	Price € m/pc	Art.-No.	Price € m/pc					
200	32	315,00	90,00	225,00	1500	750,00	1313332		2213333		2413333		2713332		1	10
200	40	315,00	110,00	225,00	1500	750,00	1313334		2213335		2413335		2713334		1	10
200	50	315,00	110,00	225,00	1500	750,00	1313336		2213337		2413337		2713336		1	10
200	63	315,00	125,00	225,00	1500	750,00	1313338		2213339		2413339		2713338		1	10
200	75	315,00	140,00	225,00	1500	750,00	1313340		2213341		2413341		2713340		1	10
200	90	315,00	160,00	225,00	1500	750,00	1313342		2213343		2413343		2713342		1	10
200	110	315,00	200,00	225,00	1500	750,00	1313344		2213345		2413345		2713344		1	10
200	125	315,00	225,00	225,00	1500	750,00	1313346		2213347		2413347		2713346		1	10
200	160	315,00	250,00	225,00	1500	750,00	1313350		2213351		2413351		2713350		1	10
250	32	400,00	90,00	225,00	1500	750,00	1313382		2213383		2413383		2713382		1	10
250	40	400,00	110,00	225,00	1500	750,00	1313384		2213385		2413385		2713384		1	10
250	50	400,00	110,00	225,00	1500	750,00	1313386		2213387		2413387		2713386		1	10
250	63	400,00	125,00	225,00	1500	750,00	1313388		2213389		2413389		2713388		1	10
250	75	400,00	140,00	225,00	1500	750,00	1313390		2213391		2413391		2713390		1	10
250	90	400,00	160,00	225,00	1500	750,00	1313392		2213393		2413393		2713392		1	10
250	110	400,00	200,00	225,00	1500	750,00	1313394		2213395		2413395		2713394		1	10
250	125	400,00	225,00	225,00	1500	750,00	1313396		2213397		2413397		2713396		1	10
250	160	400,00	250	225,00	1500,00	750,00	1313400		2213401		2413401		2713400		1	10
250	200	400,00	315	225,00	1500,00	750,00	1313402		2213403		2413403		2713402		1	10
315	32	450,00	90,00	225,00	1500	750,00			2213407				2713406		1	10
315	40	450,00	110,00	225,00	1500	750,00			2213409				2713408		1	10
315	50	450,00	110,00	225,00	1500	750,00			2213411				2713410		1	10
315	63	450,00	125,00	225,00	1500	750,00			2213413				2713412		1	10
315	75	450,00	140,00	225,00	1500	750,00			2213415				2713414		1	10
315	90	450,00	160,00	225,00	1500	750,00			2213417				2713416		1	10
315	110	450,00	200,00	225,00	1500	750,00			2213419				2713418		1	10
315	125	450,00	225,00	225,00	1500	750,00			2213421				2713420		1	10
315	160	450,00	250,00	225,00	1500	750,00			2213425				2713424		1	10
315	200	450,00	315,00	225,00	1500,00	750,00			2213429				2713428		1	10
315	250	450,00	400,00	225,00	1500,00	750,00			2213433				2713432		1	10

On request available: aquatherm green pipe ti SDR7,4

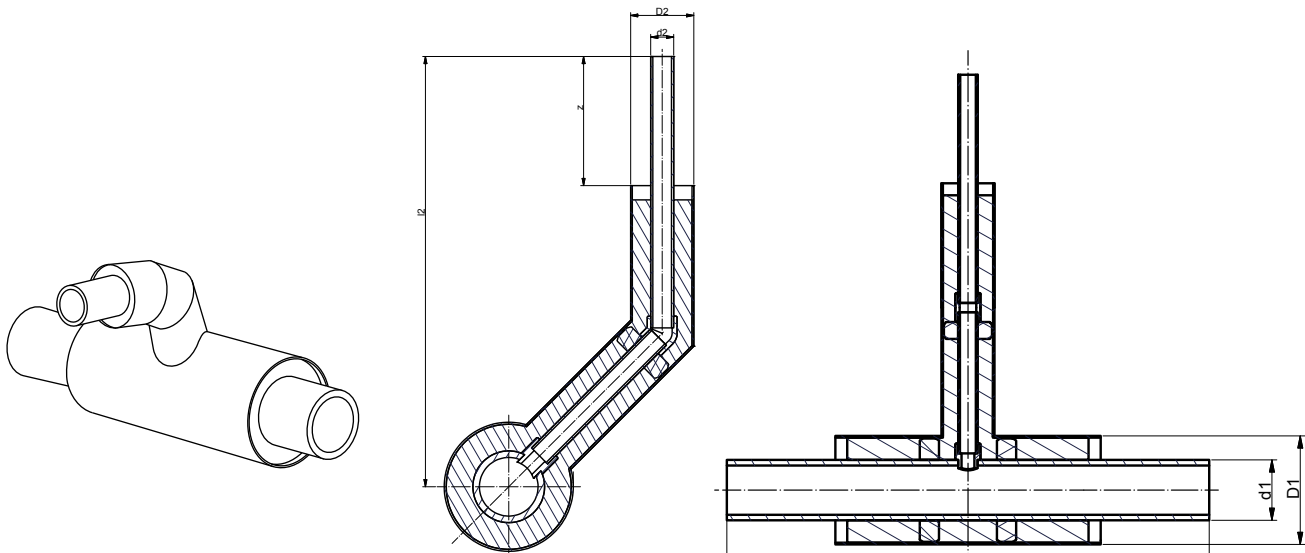

**aquatherm ti - RED. CROSS-OVER BRANCH SL 500/750**  
with PUR rigid foam and coated with a casing pipe made of PEHD

Outside diameter							System								PU	Box unit
d1 Medium pipe	d2 Medium pipe	D1 Casing pipe	D2 Casing pipe	z	l1	l2	aquatherm green pipe ti SDR 9	aquatherm blue pipe ti SDR 11	aquatherm blue pipe ot ti SDR 11	aquatherm blue pipe ti SDR 17,6						
							Art.- No.	Price € m/pc	Art.- No.	Price € m/pc	Art.- No.	Price € m/pc				
40	32	110,00	90,00	225,00	1000	750,00	1318202		2218202		2418202					1
50	32	110,00	90,00	225,00	1000	750,00	1318206		2218206		2418206					1
50	40	110,00	110,00	225,00	1000	750,00	1318208		2218208		2418208					1
63	32	125,00	90,00	225,00	1000	750,00	1318212		2218212		2418212					1
63	40	125,00	110,00	225,00	1000	750,00	1318214		2218214		2418214					1
63	50	125,00	110,00	225,00	1000	750,00	1318216		2218216		2418216					1
75	32	140,00	90,00	225,00	1000	750,00	1318220		2218220		2418220					1
75	40	140,00	110,00	225,00	1000	750,00	1318222		2218222		2418222					1
75	50	140,00	110,00	225,00	1000	750,00	1318224		2218224		2418224					1
75	63	140,00	125,00	225,00	1000	750,00	1318226		2218226		2418226					1
90	32	160,00	90,00	225,00	1000	750,00	1318230		2218230		2418230					1
90	40	160,00	110,00	225,00	1000	750,00	1318232		2218232		2418232					1
90	50	160,00	110,00	225,00	1000	750,00	1318234		2218234		2418234					1
90	63	160,00	125,00	225,00	1000	750,00	1318236		2218236		2418236					1
90	75	160,00	140,00	225,00	1000	750,00	1318238		2218238		2418238					1
110	32	200,00	90,00	225,00	1000	750,00	1318242		2218242		2418242					1
110	40	200,00	110,00	225,00	1000	750,00	1318244		2218244		2418244					1
110	50	200,00	110,00	225,00	1000	750,00	1318246		2218246		2418246					1
110	63	200,00	125,00	225,00	1000	750,00	1318248		2218248		2418248					1
110	75	200,00	140,00	225,00	1000	750,00	1318250		2218250		2418250					1
110	90	200,00	160,00	225,00	1000	750,00	1318252		2218252		2418252					1
125	32	225,00	90,00	225,00	1000	750,00	1318256		2218256		2418256					1
125	40	225,00	110,00	225,00	1000	750,00	1318258		2218258		2418258					1
125	50	225,00	110,00	225,00	1000	750,00	1318260		2218260		2418260					1
125	63	225,00	125,00	225,00	1000	750,00	1318262		2218262		2418262					1
125	75	225,00	140,00	225,00	1000	750,00	1318264		2218264		2418264					1
125	90	225,00	160,00	225,00	1000	750,00	1318266		2218266		2418266					1
125	110	225,00	200,00	225,00	1000	750,00	1318268		2218268		2418268					1
160	32	250,00	90,00	225,00	1000	750,00	1318290		2218291		2418291		2718290			1
160	40	250,00	110,00	225,00	1000	750,00	1318292		2218293		2418293		2718292			1
160	50	250,00	110,00	225,00	1000	750,00	1318294		2218295		2418295		2718294			1
160	63	250,00	125,00	225,00	1000	750,00	1318296		2218297		2418297		2718296			1
160	75	250,00	140,00	225,00	1000	750,00	1318298		2218299		2418299		2718298			1
160	90	250,00	160,00	225,00	1000	750,00	1318300		2218301		2418301		2718300			1
160	110	250,00	200,00	225,00	1000	750,00	1318302		2218303		2418303		2718302			1
160	125	250,00	225,00	225,00	1000	1000,00	1318304		2218305		2418305		2718304			1

On request available: aquatherm green pipe ti SDR7,4

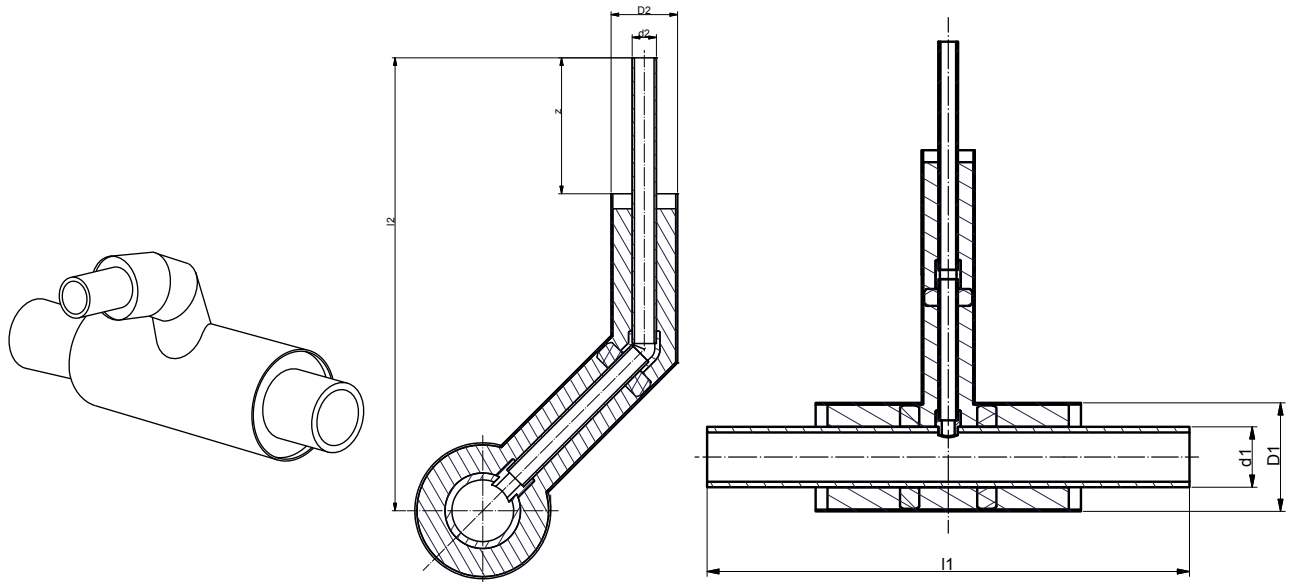

**aquatherm ti - RED. CROSS-OVER BRANCH SL 500/750**

with PUR rigid foam and coated with a casing pipe made of PEHD

Outside diameter				System							PU	Box unit				
d1 Medium pipe	d2 Medium pipe	D1 Casing pipe	D2 Casing pipe	z	l1	l2	aquatherm green pipe ti SDR 9	aquatherm blue pipe ti SDR 11	aquatherm blue pipe ot ti SDR 11	aquatherm blue pipe ti SDR 17,6						
Art.-No.	Price € m/pc	Art.-No.	Price € m/pc	Art.-No.	Price € m/pc	Art.-No.	Price € m/pc	Art.-No.	Price € m/pc	Art.-No.	Price € m/pc	Art.-No.	Price € m/pc			
200	32	315,00	90,00	225,00	1000	750,00	1318332		2218333		2418333		2718332		1	10
200	40	315,00	110,00	225,00	1000	1000,00	1318334		2218335		2418335		2718334		1	10
200	50	315,00	110,00	225,00	1000	1000,00	1318336		2218337		2418337		2718336		1	10
200	63	315,00	125,00	225,00	1000	1000,00	1318338		2218339		2418339		2718338		1	10
200	75	315,00	140,00	225,00	1000	1000,00	1318340		2218341		2418341		2718340		1	10
200	90	315,00	160,00	225,00	1000	1000,00	1318342		2218343		2418343		2718342		1	10
200	110	315,00	200,00	225,00	1000	1000,00	1318344		2218345		2418345		2718344		1	10
200	125	315,00	225,00	225,00	1500	1000,00	1318346		2218347		2418347		2718346		1	10
200	160	315,00	250,00	225,00	1500	1000,00	1318350		2218351		2418351		2718350		1	10
250	32	400,00	90,00	225,00	1000	1000,00	1318382		2218383		2418383		2718382		1	10
250	40	400,00	110,00	225,00	1000	1000,00	1318384		2218385		2418385		2718384		1	10
250	50	400,00	110,00	225,00	1000	1000,00	1318386		2218387		2418387		2718386		1	10
250	63	400,00	125,00	225,00	1000	1000,00	1318388		2218389		2418389		2718388		1	10
250	75	400,00	140,00	225,00	1000	1000,00	1318390		2218391		2418391		2718390		1	10
250	90	400,00	160,00	225,00	1000	1000,00	1318392		2218393		2418393		2718392		1	10
250	110	400,00	200,00	225,00	1000	1000,00	1318394		2218395		2418395		2718394		1	10
250	125	400,00	225,00	225,00	1000	1000,00	1318396		2218397		2418397		2718396		1	10
250	160	400,00	250,00	225,00	1500	1000,00	1318400		2218401		2418401		2718400		1	10
250	200	400,00	315,00	225,00	1500	1000,00	1318402		2218403		2418403		2718402		1	10
315	32	450,00	90,00	225,00	1000	1000,00			2218407				2718406		1	10
315	40	450,00	110,00	225,00	1000	1000,00			2218409				2718408		1	10
315	50	450,00	110,00	225,00	1000	1000,00			2218411				2718410		1	10
315	63	450,00	125,00	225,00	1000	1000,00			2218413				2718412		1	10
315	75	450,00	140,00	225,00	1000	1000,00			2218415				2718414		1	10
315	90	450,00	160,00	225,00	1000	1000,00			2218417				2718416		1	10
315	110	450,00	200,00	225,00	1000	1000,00			2218419				2718418		1	10
315	125	450,00	225,00	225,00	1000	1000,00			2218421				2718420		1	10
315	160	450,00	250,00	225,00	1000	1000,00			2218425				2718424		1	10
315	200	450,00	315,00	225,00	1500	1000,00			2218429				2718428		1	10
315	250	450,00	400,00	225,00	1500,00	1000,00			2218433				2718432		1	10

On request available: aquatherm green pipe ti SDR7,4

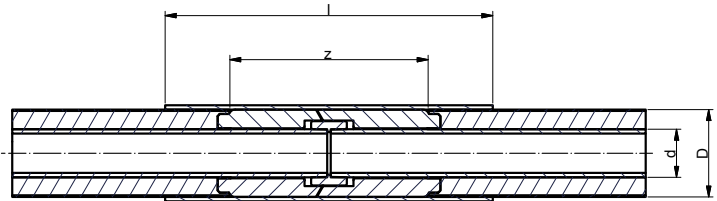

### aquatherm ti - SOCKET CSC-X

consists of shrink sleeve with PUR-rigid foam insulation elements and accessories, 750 mm total lengths

Outside diameter				System aquatherm ti		PU	Box unit
Medium pipe d	Casing pipe D	z	l	Art.-No.	Price € m/pc		
Socket welding: the fitting for the connection of the medium pipes is included in delivery.							
32	90,00	454,50	750,00	1211012		1	
40	110,00	456,50	750,00	1211014		1	
50	110,00	456,00	750,00	1211016		1	
63	125,00	455,50	750,00	1211018		1	
75	140,00	456,50	750,00	1211020		1	70
90	160,00	456,50	750,00	1211022		1	
110	200,00	458,00	750,00	1211024		1	
125	225,00	460,00	750,00	1211026		1	
Butt welding: no fitting is required for the connection of the medium pipes							
160	250,00	445,00	750,00	1211030		1	
200	315,00	444,00	750,00	1211034		1	
250	400,00	444,00	750,00	1211038		1	
315	450,00	444,00	750,00	1211042		1	

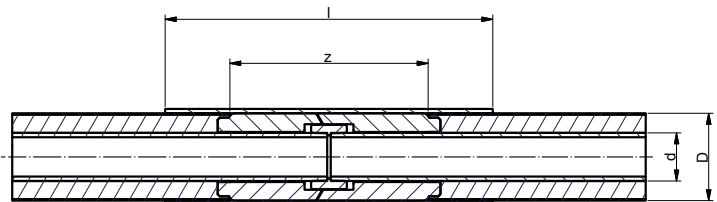

### aquatherm ti - SOCKET PLA

consists of shrink sleeve with PUR-rigid foam insulation elements and accessories, 650 mm total lengths

Outside diameter				System aquatherm ti		PU	Box unit
Medium pipe d	Casing pipe D	z	l	Art.-No.	Price € m/pc		
Socket welding: the fitting for the connection of the medium pipes is included in delivery.							
32	90,00	454,50	650	2211012		1	
40	110,00	456,50	650	2211014		1	
50	110,00	456,00	650	2211016		1	
63	125,00	455,50	650	2211018		1	
75	140,00	456,50	650	2211020		1	70
90	160,00	456,50	650	2211022		1	
110	200,00	458,00	650	2211024		1	
125	225,00	460,00	650	2211026		1	
Butt welding: no fitting is required for the connection of the medium pipes							
160	250,00	445,00	650	2211030		1	
200	315,00	444,00	650	2211034		1	
250	400,00	444,00	650	2211038		1	



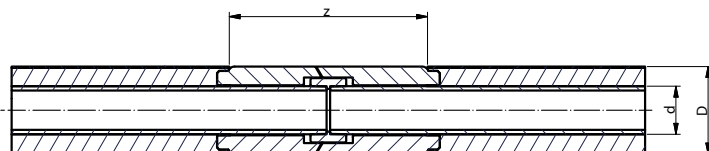

### aquatherm ti - INSULATION-SOCKET-SET

Consists of PUR-rigid foam elements and a fitting (socket up to 125 mm) depending on the dimension.

Required accessories for the installation: insulating tape and primer (p. 58)

Outside diameter			System		PU	Box unit
Medium pipe d	Casing pipe D	z	aquatherm ti			
			Art.-No.	Price € m/pc		
Socket welding: the fitting for the connection of the medium pipes is included in delivery.						
32	90,00	454,50	<b>2411012</b>		1	
40	110,00	456,50	<b>2411014</b>		1	
50	110,00	456,00	<b>2411016</b>		1	
63	125,00	455,50	<b>2411018</b>		1	
75	140,00	456,50	<b>2411020</b>		1	
90	160,00	456,50	<b>2411022</b>		1	
110	200,00	458,00	<b>2411024</b>		1	
125	225,00	460,00	<b>2411026</b>		1	
Butt welding: no fitting is required for the connection of the medium pipes						
160	250,00	445,00	<b>2411030</b>		1	
200	315,00	444,00	<b>2411034</b>		1	
250	400,00	444,00	<b>2411038</b>		1	
315	450,00	444,00	<b>2411042</b>		1	

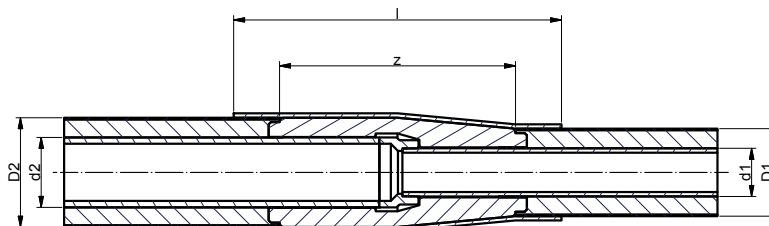

### aquatherm ti - REDUCING SOCKET

consists of shrink sleeve with PUR-rigid foam insulation elements, fitting depending on dimension and accessories, 900 mm total lengths

Outside diameter						System		PU	Box unit
d1 Medium pipe	d2 Medium pipe	D1 Casing pipe	D2 Casing pipe	z	l	aquatherm green pipe ti SDR 9 aquatherm blue pipe ti SDR 11			
						Art.-No.	Price € m/pc		
Socket welding: up to 125 x 110 mm, than onesided socket- and onesided butt welding									
40	32	90,00	110,00	456,00	900,00	<b>1211222</b>		1	10
50	32	90,00	110,00	456,00	900,00	<b>1211228</b>		1	10
50	40	110,00	125,00	456,00	900,00	<b>1211230</b>		1	10
63	40	110,00	125,00	455,50	900,00	<b>1211236</b>		1	10
63	50	110,00	140,00	455,50	900,00	<b>1211238</b>		1	10
75	50	110,00	140,00	456,50	900,00	<b>1211240</b>		1	10
75	63	125,00	160,00	456,50	900,00	<b>1211242</b>		1	10
90	63	125,00	160,00	456,50	900,00	<b>1211252</b>		1	10
90	75	140,00	200,00	456,50	900,00	<b>1211253</b>		1	10
110	75	140,00	200,00	458,00	900,00	<b>1211257</b>		1	10
110	90	160,00	225,00	458,00	900,00	<b>1211259</b>		1	10
125	90	160,00	225,00	458,00	900,00	<b>1211263</b>		1	10
125	110	200,00	250,00	460,00	900,00	<b>1211265</b>		1	10

Outside diameter						aquatherm green pipe ti SDR 9		aquatherm blue pipe ti SDR 11		aquatherm blue pipe ti SDR 17,6		PU	Box unit
d1 Medium pipe	d2 Medium pipe	D1 Casing pipe	D2 Casing pipe	z	l	Art.-No.	Price € m/pc	Art.-No.	Price € m/pc	Art.-No.	Price € m/pc		
160	110	200,00	250,00	540,00	750,00	1311274		2211275		2711274		1	10
160	125	225,00	315,00	540,00	750,00	1311276		2211277		2711276		1	10
200	125	225,00	315,00	585,00	750,00	1311282		2211283		2711282		1	10
Double-sided butt welding													
200	160	250,00	400,00	585,00	750,00	1311284		2211285		2711284		1	10
250	160	250,00	400,00	622,00	750,00	1311288		2211289		2711288		1	10
250	200	315,00	400,00	622,00	750,00	1311290		2211291		2711290		1	10
315	200	315	450,00	622,00	750,00	1311296		2211297		2711296		1	10
315	250	400	450,00	622,00	750,00	1311298		2211299		2711298		1	10

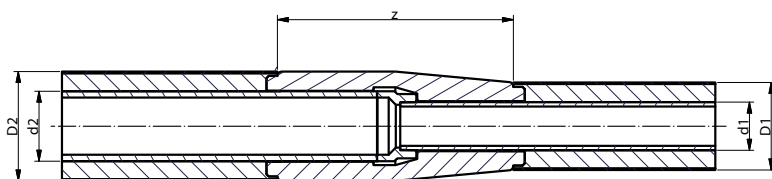

### aquatherm ti - INSULATION-REDUCING SOCKET-SET

consists of PUR-rigid foam elements and fitting. Required accessories: insulating tape and primer

Outside diameter						System						PU	Box unit
						aquatherm ti							
d2	d1	D1	D2	z	l	Art.-No.		Price € m/pc					
Socket welding: up to 125 x 110 mm, than onesided socket- and onesided butt welding													
40	32	90,00	110,00	456,00	900,00	2411222						1	
50	32	90,00	110,00	456,00	900,00	2411228						1	
50	40	110,00	125,00	456,00	900,00	2411230						1	
63	40	110,00	125,00	455,50	900,00	2411236						1	
63	50	110,00	140,00	455,50	900,00	2411238						1	
75	50	110,00	140,00	456,50	900,00	2411240						1	
75	63	125,00	160,00	456,50	900,00	2411242						1	
90	63	125,00	160,00	456,50	900,00	2411252						1	
90	75	140,00	200,00	456,50	900,00	2411253						1	
110	75	140,00	200,00	458,00	900,00	2411257						1	
110	90	160,00	225,00	458,00	900,00	2411259						1	
125	90	160,00	225,00	458,00	900,00	2411263						1	
125	110	200,00	250,00	460,00	900,00	2411265						1	
Outside diameter						aquatherm green pipe ti SDR 9		aquatherm blue pipe ti SDR 11		aquatherm blue pipe ti SDR 17,6		LE	PG
d2	d1	D1	D2	z	l	Art.-No.	Price € m/pc	Art.-No.	Price € m/pc	Art.-No.	Price € m/pc		
160	110	200,00	250,00	540,00	750,00	2411274		2411275		2711275		1	
160	125	225,00	315,00	540,00	750,00	2411276		2411277		2711277		1	
200	125	225,00	315,00	585,00	750,00	2411282		2411283		2711283		1	
Double-sided butt welding													
200	160	250,00	400,00	585,00	750,00	2411284		2411285		2711285		1	
250	160	250,00	400,00	622,00	750,00	2411288		2411289		2711289		1	
250	200	315,00	400,00	622,00	750,00	2411290		2411291		2711291		1	
315	200	315	450,00	622,00	750,00	2411296		2411297		2711297		1	
315	250	400	450,00	622,00	750,00	2411298		2411299		2711299		1	

### aquatherm ti - MONO TOP 40 INSULATION TAPE

for post-insulation of connections with the aquatherm-insulation-socket set

Art.-No.	Wide	Length	Price € m/pc	PU	Box unit
2411000	50 mm	15 m		1	
2411001	100 mm	15 m		1	

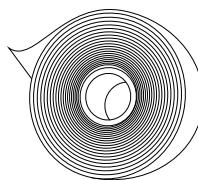

### aquatherm ti - PRIMER

Art.-No.	Amount	Price € m/pc	PU	Box unit
2411002	1 liter		1	



### aquatherm ti - CLOSING COLLAR

Collar for closing the PUR-insulating layer from casing pipe to medium

Outside diameter		System		PU	Box unit
Medium pipe	Casing pipe	aquatherm ti			
		Art.-No.	Price € m/pc		
32 mm	90 mm	1214112		1	
40-50 mm	110 mm	1214114		1	
63-75 mm	125-140 mm	1214118		1	
90 mm	160 mm	1214122		1	
110 mm	200 mm	1214124		1	
125 mm	225 mm	1214126		1	
160 mm	250 mm	1214130		1	
200 mm	315 mm	1214134		1	
250 mm	400 mm	1214138		1	
315 mm	450 mm	1214142		1	



### aquatherm ti - COMPACT SEALS

Pipe collar for wall duct.

Outside diameter			System		PU	Box unit
Core drill hole	Medium pipe	Casing pipe	aquatherm ti			
			Art.-No.	Price € m/pc		
150	32	90	1214212		1	
200	40-50	110	1214214		1	
200	63	125	1214218		1	
200	75	140	1214220		1	
250	90	160	1214222		1	
300	110	200	1214224		1	
350	125	225	1214226		1	
350	160	250	1214230		1	
400	200	315	1214234		1	

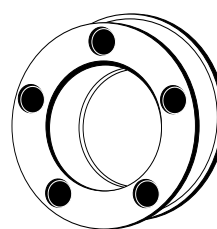

### aquatherm ti - WARNING TAPE

Art.-No.	Width	Price € m/pc	PU	Box unit
50191	40 mm		250m	10

Colour: yellow

Printing in black: "Attention district heating pipeline"

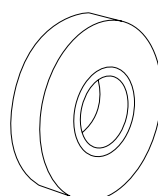



APPLICATIONS

















Management  
System  
ISO 9001:2008  
ISO 14001:2004  
ISO 50001:2011  
[www.tuv.com](http://www.tuv.com)  
ID 0091005348

## **aquatherm GmbH**

Biggen 5 | D-57439 Attendorn | Phone: +49 (0) 2722 950-0 | Fax: +49 (0) 2722 950-100

Wilhelm-Rönsch-Str. 4 | D-01454 Radeberg | Phone: +49 (0) 3528 4362-0 | Fax: +49 (0) 3528 4362-30

[info@aquatherm.de](mailto:info@aquatherm.de) [www.aquatherm.de](http://www.aquatherm.de)